



HURST-ROSCHÉ, INC.

CONTRACT DOCUMENTS

and

SPECIFICATIONS

SANITARY SEWER REPAIR TWO LOCATIONS

CAHOKIA HEIGHTS

Project Funded by:

**Illinois Environmental
Protection Agency Grant**

Prepared by

**Hurst-Rosche, Inc.
5 Bank Square
East St. Louis, Illinois
H-R 860-0683**

August 2023

Bid Package No. _____

TABLE OF CONTENTS

<u>Title</u>	<u>Page</u>
Advertisement for Bids	AFB-1
Instructions to Bidders	00100-1-5
Bid	B-1-2
Bid Bond	BB-1-2
Application for Payment	00685-1
Application for Payment Continuation Sheet	00690-1
Agreement	A-1-3
Payment Bond	PayB-1-2
Performance Bond	PerB-1-2
Notice of Award	NOA-1
Notice to Proceed	NTP-1
Change Order	CO-1
Notice of Requirement for Affirmative Action to Ensure Equal Employment Opportunity (E.O. 1125)	1
Construction Contractors Affirmative Action Requirements Goals for Minority Participation	1-11
Certification of Nonsegregated Facilities	1
Notice to Labor Unions or Other Organizations of Workers Nondiscrimination in Employment	1
Certification Regarding Debarment, suspension & Other Responsibility Matters	1-2
Construction contracts of Loan Recipient & Other Sections From "Procedures for Issuing Loans from the Water Pollution Control Loan Program	1-4
Bidder Certification In compliance with Article 33E-11 to the "Criminal Code of 2012"	1
Specifications for Disadvantaged Business Enterprise Participation Suggested Disadvantaged Business (DBE) Advertisement for Construction Contractors	1-3
Summary Report of disadvantaged Business Enterprise Requirements for Contractors	1
IEPA Disadvantaged Business Enterprise (DBE) Program Form #1 Contractor Certification Form	1
IEPA Disadvantaged Business Enterprise (DBE) Program Form #3 Subcontractor Utilization Form	1
IEPA Disadvantaged Business Enterprise (DBE) Program Form #4 Bidders List	1
Bidder Certification Regarding the Use of Iron, Steel, Manufactured Products, & Construction Materials produced in the USA (Build America, Buy America Act:	1-4
Illinois Works Jobs Program Act – Apprenticeship Initiative Information for Contractors	1-7
General Conditions	GC-1-9
General Wage Decision	1-21
Standards Specifications (reference) and Index of Plans	SS-1

Detailed Specifications

<u>DIVISION</u>	<u>SECTION</u>	<u>TITLE</u>	<u>PAGES</u>
1	<u>GENERAL REQUIREMENTS</u>		
	01010	Project Summary	01010-1 -2
	01031	Additional Project Information	01031-1 -3
	01051	Grades, Lines & Levels	01051-1
	01570	Traffic Regulation	01570-1 -2
2	<u>SITE WORK</u>		
	02102	Clearing & Site Preparation	02102-1 -2
	02222	Excavation, Backfilling & Compacting for Utilities	02222-1 -4
	02400	Dewatering & Sewer Bypass	02400-1
	02480	Seeding	02480-1 -2
	02610	Pipe & Pipe Fittings Sewer	02610-1 -4
	02731	Sewer Cleaning, Main Sewers	02731-1 -2
	02732	Television Inspection, Main Sewers	02732-1 -2
	02734	Flow Control	02734-1
	02735	Cured-in-Place Pipe, Main Sewers (CIPP)	02735-1 -5

INDEX OF STANDARDS

000001-08	Standard Symbols, Abbreviations and Patterns
280001-07	Temporary Erosion Control Systems
664001-02	Chain Link Fence
701301-04	Lane Closure, 2L, 2W, Short Time Operations
701501-06	Urban Lane Closure, 2L, 2W Undivided
701901-08	Traffic Control Devices

ADVERTISEMENT FOR BIDS

Separate sealed BIDS for **Sanitary Sewer Repair, Two Locations, Cahokia Heights**, will be received at the office of **Hurst-Rosche, Inc., 5 Bank Square, East St. Louis, IL 62203** until **10:00 A.M. on 2023**, and then publicly opened and read aloud.

The project consists of furnishing all labor, materials, and equipment for the replacement of approximately 40 lineal feet of 8-inch diameter sewer, including clearing, dewatering, care of flow, cleaning & televising, and approximately 567 lineal feet of Cured-In-Place Pipe (CIPP) liner, together with reestablishment of service connections, restoration of all disturbed surfaces, and all other incidental work required to complete the project. This is a Lump Sum Contract.

All work shall be constructed under the provisions of the **Standard Specifications for Road and Bridges Construction** prepared by the Department of Transportation of the State of Illinois, adopted January 1, 2022 and the **Standard Specifications for Water and Sewer Main Construction in Illinois**, July 2009, Sixth Edition. The only exception to these standards, are all references to measurement and payment.

Plans and proposal forms may be obtained from Hurst-Rosche, Inc., 5 Bank Square, East St. Louis, IL 62203 (618/398-0890). The plan deposit is \$30.00 each (\$45.00 if mailed) and is non-refundable. Drawings and specifications will be available for viewing on the internet at: www.hurst-rosche.com. The documents are being provided for reference purposes only. At a minimum, bidders must obtain clean copies of bid forms by paying a non-refundable amount of \$10.00 to submit a bid for this project. All proposals must be accompanied by a bid bond or cashier's check for not less than five percent of the amount of the bid.

The CONTRACT DOCUMENTS may be examined at the following locations:

- a) Hurst-Rosche, Inc., 5 Bank Square, East St. Louis, IL 62203.
- b) Southern Illinois Builders Assn., 1468 Green Mount Rd., O'Fallon, IL 62269.

The federal prevailing rate of wages (Davis Bacon Act) shall be paid throughout the scope of the project. Bidders will be required to comply with the President's Executive Order No. 11246 as amended. The requirements for bidders and contractors under this order are explained in the specifications.

The OWNER reserves the right to waive technicalities or to reject any or all proposals.

Curtis McCall, Mayor

INSTRUCTIONS TO BIDDERS

SANITARY SEWER REPAIR
TWO LOCATIONS
CAHOKIA HEIGHTS

HURST-ROSCHE, INC.
NO. 5 BANK SQUARE
EAST ST. LOUIS, ILLINOIS 62203

To be considered, all Bids must be in accordance with these Instructions to Bidders. Bidders must be listed on the official plan holders list to submit a responsive bid. Documents for Bidding can be reviewed at www.hurst-rosche.com. Partial sets of bid documents will not be distributed. Plans and specifications can be obtained from the office of Hurst-Rosche, Inc. for a non-refundable deposit of \$30.00 (\$45.00 if mailed). At a minimum, bidders must obtain clean copies of bid forms by paying \$10.00 to submit a bid for this project.

Bidders shall carefully examine documents and construction site to obtain first-hand knowledge of existing conditions. Contractors will not be given extra payments for conditions which can be determined by examining site and these documents.

The schedule for bidding this project is as follows:

- | | | |
|----|--|---------------------------------|
| 1. | Plans Available: | _____ |
| 2. | Pre-Bid Meeting: | None |
| 3. | Latest Time to Submit Request for Interpretation: | _____ |
| 4. | Latest Time to Issue an Addendum: | _____ |
| 5. | Bid Opening | _____ |
| | | 10:00 A.M. |
| | | Hurst-Rosche, Inc. |
| | | 5 Bank Square |
| | | East St. Louis, IL 62203 |

All requests for interpretations shall be in writing via mail or e-mail to tsudholt@hurst-rosche.com and must be received seven (7) days prior to date fixed for opening of bids in order to be given consideration. All questions must be submitted on the "Request for Interpretation Pre-Bid Question and Comment Form" included at the end of this section, and questions not submitted in accordance with this form and specified time frame will not be accepted. Any and all interpretations and supplemental instructions will be made by addendum to the Drawings and Specifications and forwarded to all bidders either by certified mail or fax transmittal. All responses by the Owner or Architect/Engineer must be in writing to be binding. All bidders are required to return the signature page of the addendum signed to the Architect/Engineer within 24 hours after receipt. Failure of any bidder to receive any such addendum or interpretations shall not relieve such bidder from an obligation under the bid as submitted. All addenda so issued shall become part of the Contract Documents. No addendum will be issued later than three (3) days prior to bid date except one withdrawing the request for Bids or one postponing

date for receiving Bids. Oral interpretations, changes or corrections will not be binding and Bidders shall not rely upon such interpretations, changes and corrections. Each Bidder shall ascertain prior to submitting Bid that all addenda issued have been received and shall acknowledge receipt in Bid.

BIDDERS must satisfy themselves of the accuracy of the estimated quantities in the BID Schedule by examination of the site and a review of the drawings and specifications including ADDENDA. After BIDS have been submitted, the BIDDER shall not assert that there was a misunderstanding concerning the quantities of WORK or of the nature of the WORK to be done.

The OWNER shall provide to BIDDERS, prior to BIDDING, all information which is pertinent to, and delineates and describes, the land owned and rights of way acquired or to be acquired.

The CONTRACT DOCUMENTS contain the provisions required for the construction of the PROJECT. Information obtained from an officer, agent, or employee of the OWNER or any other person shall not affect the risks or obligations assumed by the CONTRACTOR or relieve him from fulfilling any of the conditions of the contract.

Materials, products and equipment described in Bidding Documents establish a standard of required function, dimension, appearance and quality to be met by any proposed substitution. No substitution will be considered prior to receipt of Bids unless written request for approval has been received by the Architect/Engineer at least ten days prior to the date for receipt of Bids. Each such request shall include name of material or equipment for which it is to be substituted and a complete description of the proposed substitute including drawings, cuts, performance and test data and any other information necessary for an evaluation. A statement setting forth any changes in other materials, equipment or other work that incorporation of the substitute would require shall be included. The burden of proof of the merit of proposed substitute is upon the proposer. Architect/Engineer's decision of approval or disapproval of a proposed substitution shall be final. If the Architect/Engineer approves any proposed substitution prior to receipt of Bids, such approval will be set forth in an addendum. Bidders shall not rely upon approvals made in any other manner. No substitutions will be considered after the contract award unless specifically provided in the Contract Documents.

Each Bidder shall designate on the Bid Form one person who shall serve as the Bidder contact person for all matters pertaining to the bid. In absence of such designation, the person who signs the bid shall be deemed the Bidder Contact.

Bids shall be made on unaltered Bid Forms furnished by the Architect/Engineer. Fill in all blank spaces and submit one original (1) copy. Bids shall be signed with name typed below signature. Where bidder is a corporation, bids must be signed with legal name of corporation followed by name of state of incorporation and legal signature of an officer authorized to bind the corporation to a contract.

Each bid shall be accompanied by bid security made payable to the Owner, in the amount of five percent (5%) of the bid sum. Security shall be either, certified check, cashier's check, bank money order or bid bond issued by surety licensed to conduct business in the State of Illinois. Successful bidder's security will be retained until he has signed the contract and furnished required payment and performance bonds. Owner reserves the right to retain security of the next two (2) lowest bidders until the lowest bidder enters into contract or until thirty (30) days after bid opening, whichever is shorter. All other bid security will be returned as soon as practicable. If any bidder refuses to enter into a contract, Owner will retain bid security as liquidated damages, but not as a penalty.

All copies of the bid, bid security and any other documents required to be submitted with bid shall be enclosed in a sealed opaque envelope. Envelope shall be addressed to Cahokia Heights, C/O Hurst-Rosche, Inc. 5 Bank Square, East St. Louis, Illinois 62203, and shall be identified with project name, bidder's name and address. Mailed bid envelopes shall be enclosed in a separate mailing envelope with the notation "SEALED BID ENCLOSED" on the face thereof. Oral, telephonic or telegraphic Bids are invalid and will not receive consideration. Bids shall be deposited at the location designated in the Advertisement for Bids prior to time and date designated for opening, or any extension thereof made by addendum. Bidder shall assume full responsibility for timely delivery at location designated for receipt of Bids. Bids received after time and date for receipt of bids will be returned unopened.

A bid may not be modified, withdrawn or canceled during the thirty (30) days immediately following bid opening, and each bidder so agrees in submitting his Bid. Any bidder may withdraw, cancel or modify its bid, at any time prior to scheduled time for opening of bids, by letter or telegram actually received by Owner prior to bid time, or, with proper identification, by personally securing bid submitted; if by telegram, written confirmation over signature of bidder shall be mailed and postmarked on or before date and time of bid opening. Withdrawn bids may be resubmitted up to bid opening time provided that they are in full compliance with these Instructions to Bidders.

All costs associated with the preparation and submission of a bid is the sole responsibility of the bidder. These costs shall not be chargeable to the Owner by any successful or unsuccessful bidder. All bids become the property of the Owner and shall not be returned except in the case of a late submission.

Protest: Any bidder who submitted a bid and believes the bid was improperly rejected or that the bid selected by the Owner is not in the best interest of the Owner may submit a written notice of intent to protest the bid to the Owner within seven (7) days. The Owner shall consider all protests before execution of a contract. Each protest must specify the reasons supporting the protest. The Owner may require that addition information be provided. Failure to supply such required information shall be cause for dismissal of the protest.

The Owner shall immediately investigate the allegations against the Owners actions and shall issue a written response to the protest.

This provision allowing for the submission of protest shall not confer any right on any bidder but is intended solely to assist the Owner in determining the best responsible bid.

Owner reserves right to disqualify bids and bidders, before or after opening, upon evidence of collusion with intent to defraud or other illegal practices upon part of bidder, lack of responsibility as evidenced by poor workmanship and progress of past work, incomplete work which in judgment of Owner might hinder or prevent prompt completion of additional work if awarded, for being in arrears on existing contracts, in litigation with the Owner, or having defaulted on a previous contract.

Bidder's attention is directed to the fact that all Federal and Illinois State Laws, municipal ordinances and regulations of any and all authority having jurisdiction over construction of the project shall apply to the contract throughout, and they will be deemed to be included in the contract the same as though herein written out in full. Successful Bidders shall be required to observe Illinois Public Act 77-1552 and the Illinois Department of Human Rights and Illinois Human Rights Commission Rules pertaining to Equal Employment Opportunity, as provided for

in Paragraphs 2-101, et seq., Article II, Chapter 68, of the Illinois Revised Statutes; Paragraph 271 of Chapter 48 of the Illinois Revised Statutes concerning the employment of citizens of the State of Illinois; and the Davis-Bacon Act known as the Prevailing Wage Act, as issued by the U.S. Department of Labor.

Owner is exempt from payment of Illinois Department of Revenue's Use and Sales Tax on material entering permanently into structure.

Owner reserves the right to reject any or all bids or any part thereof, to waive any informality in bidding and to accept bids deemed most favorable to the Owner.

The party to whom the contract is awarded will be required to execute the Agreement and obtain the performance BOND and payment BOND within ten (10) calendar days from the date when NOTICE OF AWARD is delivered to the BIDDER. The NOTICE OF AWARD shall be accompanied by the necessary Agreement and BOND forms. In case of failure of the BIDDER to execute the Agreement, the OWNER may at his option consider the BIDDER in default, in which case the BID BOND accompanying the proposal shall become the property of the OWNER.

The OWNER within ten (10) days of receipt of acceptable performance BOND, payment BOND and Agreement signed by the party to whom the Agreement was awarded shall sign the Agreement and return to such party an executed duplicate of the Agreement. Should the OWNER not execute the Agreement within such period, the BIDDER may by WRITTEN NOTICE withdraw his signed Agreement. Such notice of withdrawal shall be effective upon receipt of the notice by the OWNER.

Notwithstanding any delay in preparation and execution of the formal Contract Agreement, each bidder shall be prepared, upon written notice of bid acceptance, to commence work within seven (7) days following receipt of official written Notice to Proceed, or on date stipulated in such notice. Should there be reasons why the NOTICE TO PROCEED cannot be issued within such period the time may be extended by mutual agreement between the OWNER and CONTRACTOR. If the NOTICE TO PROCEED has not been issued within the ten (10) day period or within the period mutually agreed upon, the CONTRACTOR may terminate the Agreement without further liability on the part of either party.

The OWNER may make such investigations as he deems necessary to determine the ability of the BIDDER to perform the WORK, and the BIDDER shall furnish to the OWNER all such information and data for this purpose as the OWNER may request.

A conditional or qualified BID will not be accepted.

Award will be made to the lowest responsible BIDDER for the Lump Sum Contract Amount.

Accepted bidder shall assist and cooperate with the Owner in preparing the formal Contract Agreement and, within fifteen (15) days following its presentation, shall execute same and return it to Owner.

Contract Time: Time of Substantial Completion for the project shall not be later than 60 consecutive calendar days from date stipulated in written Notice to Proceed.

The consulting engineer is Hurst-Rosche, Inc., 5 Bank Square, East St. Louis, Illinois, (618/398-0890).

BID

Proposal of _____

(hereinafter called "BIDDER"), organized and existing under the laws of the State of _____

_____, doing business as * _____

*Insert "a corporation," "a partnership," or "an individual," as applicable.

To **CAHOKIA HEIGHTS** (hereinafter called "OWNER").

In compliance with your Advertisement for Bids, BIDDER hereby proposes to perform all WORK for the improvements of **SANITARY SEWER REPAIR, TWO LOCATIONS, CAHOKIA HEIGHTS**. The project consists of furnishing all labor, materials, and equipment for the replacement of approximately 40 lineal feet of 8-inch diameter sewer, including clearing, dewatering, care of flow, cleaning & televising, and approximately 567 lineal feet of Cured-In-Place Pipe (CIPP) liner, together with reestablishment of service connections, restoration of all disturbed surfaces, and all other incidental work required to complete the project in strict accordance with the CONTRACT DOCUMENTS, within the time set forth therein, and at the prices stated below.

BIDDER hereby agrees to commence WORK under this contract on or before a date to be specified in the NOTICE TO PROCEED and to fully complete the PROJECT within 60 consecutive calendar days thereafter.

(I) By submission of the bid, each bidder certifies, and in the case of a joint bid, each party thereto certifies as to his own organization, that in connection with the bid:

- (i) The prices in the bid have been arrived at independently, without consultation, communication, or agreement, for the purpose of restricting competition, as to any matter relating to such prices with any other bidder or with any competitor;
- (ii) Unless otherwise required by law, the prices which have been quoted in the bid have not knowingly been disclosed by the bidder, prior to opening, directly or indirectly to any other bidder or to any competitor; and
- (iii) No attempt has been made or will be made by the bidder to induce any other person or firm to submit or not to submit a bid for the purpose of restricting competition.

(II) Each person signing the bid shall certify that:

- (i) He is the person in the bidder's organization responsible within that organization for the decision as to the prices being bid and that he has not participated, and will not participate, in any action contrary to (I) (i) through (I) (iii) above; or
- (ii) He is not the person in the bidder's organization responsible within that organization

**SANITARY SEWER REPAIR
TWO LOCATIONS
CAHOKIA HEIGHTS**

Dated _____

This proposal consists of 2 pages.

for the decision as to the prices being bid, but that he has been authorized to act as agent for the persons responsible for such decision in certifying that such persons have not participated, and will not participate, in any action contrary to (I) (i) through (I) (iii) above, and as their agent, shall so certify; and shall also certify that he has not participated, and will not participate, in any action contrary to (I) (i) through (I) (iii) above.

- (iii) The Contractor by submitting its bid certifies that it will provide a drug free workplace and that it is in compliance with the requirements of the Drug Free Workplace Act 30ILCS 580.1 et.seq., and the Substance Abuse Prevention on Public Works Projects Act PA095—635.

BIDDER acknowledges receipt of the following ADDENDA:

No. _____, dated _____ No. _____, dated _____
 No. _____, dated _____ No. _____, dated _____

BIDDER agrees to perform all work described in the CONTRACT DOCUMENTS for the following lump sum price:

<u>Location</u>	<u>Bid Amount</u>
1. 327 N. 63 rd STREET	\$ _____
2. 310 N. 73 rd STREET	\$ _____
TOTAL LUMP SUM BID (in figures)	\$ _____
TOTAL LUMP SUM BID IN WRITING _____	_____

Name of Bidder (FIRM) _____
 Signed by _____
 Title _____ Date _____
 Business Address _____

 Treasury Number _____
 Contact Person _____

(SEAL)
 If Bid is by a corporation - Social Security Number (if private owner) _____

Attest: _____

**SANITARY SEWER REPAIR
 TWO LOCATIONS
 CAHOKIA HEIGHTS**

Dated _____

This proposal consists of 2 pages.

BID BOND

KNOW ALL MEN BY THESE PRESENTS, that we, the undersigned, _____

_____ as Principal, and

_____ as Surety, are hereby

held and firmly bound unto _____ as Owner

in the penal sum of _____

for the payment of which, well and truly to be made, we hereby jointly and severally bind ourselves, successors and assigns.

Signed, this _____ day of _____, 20_____

The Condition of the above obligation is such that whereas the Principal has submitted to _____ a certain BID.

Attached hereto and hereby made a part hereof to enter into a contract in writing, for the

NOW, THEREFORE,

- (a) If said BID shall be rejected, or
- (b) If said BID shall be accepted and the Principal shall execute and deliver a contract in the Form of contract attached hereto (properly complete in accordance with said BID) and shall furnish a BOND for his faithful performance of said contract, and for the payment of all persons performing labor or furnishing materials in connection therewith, and shall in all other respects perform the agreement created by the acceptance of said BID. Then this obligation shall be void, otherwise the same shall remain in force and effect; it being expressly understood and agreed that the liability of the Surety for any and all claims hereunder shall, in no event, exceed the penal amount of this obligation as herein stated.

The Surety, for value received, hereby stipulates and agrees that the obligations of said Surety and its BOND shall be in no way impaired or affected by any extension of the time within which the OWNER may accept such BID; and said Surety does hereby waive notice of any such extension.

IN WITNESS WHEREOF, the Principal and the Surety have hereunto set their hands and seals, and such of them as are corporations have caused their corporate seals to be hereto affixed and these presents to be signed by their proper officers, the day and year first set forth above.

Principal

Surety

By: _____

IMPORTANT-Surety companies executing BONDS must appear on the Treasury Department's most current list (Circular 570 as amended) and be authorized to transact business in the state where the project is located.



APPLICATION FOR PAYMENT

Page _____ of _____

Owner: _____
 Cahokia Heights _____
 103 Main Street _____
 Cahokia, IL 62206 _____

Project: Sanitary Sewer Repair
Two Locations
Cahokia Heights
HR 860-0683

Application No. _____
 Period to: _____
 Project No.: _____
 Contract Date: _____

Contractor: _____

Architect/Engineer: Hurst-Rosche, Inc.

Original Contract Sum	_____	
Net Change By Change Orders	_____	
Contractor Sum to Date	_____	
Total Completed & Stored to Date	_____	
Retainage: ____% of completed work	_____	
____% of Stored Materials	_____	
Total Retainage	_____	
Total Earned Less Retainage	_____	
Less Previous Applications for Payment	_____	
CURRENT PAYMENT DUE	_____	
Balance to Finish (including Retainage)	_____	

The undersigned certifies that to the best of their knowledge, information and belief the work covered by the application has been completed in accordance with the contract documents, that all amounts have been paid by the contractor for work which previous payments were issued and payments received from the Owner, and that current payment shown is now due.

Contractor:

_____ Signature

_____ Date

State of Illinois

County of _____

Subscribed and sworn to before me on this ____ day of _____

 Notary Public

My Commission Expires: _____

In accordance with the contract documents, based on on-site observations and the on this application, the Architect certifies that to the best of his knowledge, information and belief the work completed is proportionate to the dollar amount requested, quality of work is in accordance with contract requirements and the Contractor is entitled to payment in the amount of _____

Summary of Change Orders	Additions	Deletions
Total previous approved change orders	_____	_____
Total current approved change orders	_____	_____
NET TOTAL OF CHANGE ORDERS	_____	_____

 Curtis McCall, Mayor of Cahokia Heights _____ Date

 Architect/Engineer's Representative

Hurst-Rosche, Inc.

_____ Signature

_____ Date



APPLICATION FOR PAYMENT CONTINUATION SHEET

Page _____ of _____

Application No. _____
 Period to: _____
 Project No.: 860-0683
 Contract Date: _____
 Invoice No. _____
 Contractor for: _____

Amounts lists below are states to the nearest dollar.

Item No.	Description of Work	Scheduled Value	Worked Completed		Materials Presently Stored	Total Completed and Stored to Date	%	Balance to Finish	Retainage
			From Previous Application	This Period					

AGREEMENT

H-R 860-0683

THIS AGREEMENT, made this _____ day of _____, 20____, by and between
Cahokia Heights, hereinafter called "Owner" and _____
Name of Owner),
_____doing business as an, individual, partnership or corporation,
hereinafter called "CONTRACTOR".

WITNESSETH: That for and in consideration of the payments and agreements hereinafter mentioned:

1. The CONTRACTOR will commence and complete the construction of
Sanitary Sewer Repair, Two Locations, Cahokia Heights
2. The CONTRACTOR will furnish all of the material, supplies, tools, equipment, labor and other services necessary for the construction and completion of the PROJECT described herein.
3. The CONTRACTOR will commence the work required by the CONTRACT DOCUMENTS within 10 calendar days after the date of the NOTICE TO PROCEED and will complete the same within 60 calendar days unless the period for completion is extended otherwise by the CONTRACT DOCUMENTS.
4. The CONTRACTOR agrees to perform all of the WORK described in the CONTRACT DOCUMENTS and comply with the terms therein for the sum of \$_____ or as shown in the BID schedule.
5. The term "CONTRACT DOCUMENTS" means and includes the following:
 - (A) Advertisement for BIDS
 - (B) Information for BIDDERS
 - (C) BID
 - (D) BID BOND
 - (E) Agreement

A-1

(F) General Conditions

(G) SUPPLEMENTAL GENERAL CONDITIONS

(H) Payment BOND

(I) Performance BOND

(J) NOTICE OF AWARD

(K) NOTICE TO PROCEED

(L) CHANGE ORDER

(M) DRAWINGS prepared by Hurst-Rosche, Inc.
numbered 1 through 4, and dated August, 2023

(N) SPECIFICATIONS prepared or issued by Hurst-Rosche, Inc.
dated August, 2023

(O) ADDENDA:

No. _____, dated _____, 20

No. _____, dated _____, 20

No. _____, dated _____, 20

No. _____, dated _____, 20

6. The OWNER will pay to the CONTRACTOR in the manner and at such times as set forth in the General Conditions such amounts as required by the CONTRACT DOCUMENTS.

7. This Agreement shall be binding upon all parties hereto and their respective heirs, executors, administrators, successors, and assigns.

IN WITNESS WHEREOF, the parties hereto have executed, or caused to be executed by their duly authorized officials, this Agreement in (3) each of which shall be deemed an original on the date first above written.

(Number of Copies)

OWNER:

Cahokia Heights

BY _____

Name Curtis McCall
(Please Type)

Title Mayor

SEAL)

ATTEST: _____

Name Richard Duncan
(Type)

Title City Clerk

CONTRACTOR:

BY _____

Name _____
(Please Type)

Address _____

(SEAL)

ATTEST:

Name _____
(Please Type)

Title _____

PAYMENT BOND

KNOW ALL MEN BY THESE PRESENTS: that

_____ (Name of Contractor)

_____ (Address of Contractor)

a _____, hereinafter called Principal,
(Corporation, Partnership or Individual)

and _____ (Name of Surety)

_____ (Address of Surety)

hereinafter called Surety, are held and firmly bound unto _____

_____ (Name of Owner)

_____ (Address of Owner)

hereinafter called OWNER, in the penal sum of _____ Dollars, \$(_____)

in lawful money of the United States, for the payment of which sum well and truly to be made, we bind ourselves, successors, and assigns, jointly and severally, firmly by these presents.

THE CONDITION OF THIS OBLIGATION is such that whereas, the Principal entered into a certain contract with the OWNER, dated the _____ day of _____ 20 _____, a copy of which is hereto attached and made a part hereof for the construction of:

NOW, THEREFORE, if the Principal shall promptly make payment to all persons, firms, SUBCONTRACTORS, and corporations furnishing materials for or performing labor in the prosecution of the WORK provided for in such contract, and any authorized extension, or modification, thereof, including all amounts due for materials, lubricants, oil, gasoline, coal and coke, repairs on machinery, equipment and tools; consumed or used in connection with the construction of such WORK, and all insurance premiums on said WORK, and for all labor, performed in such work whether by SUBCONTRACTOR or otherwise, then this obligation shall be void; otherwise to remain in full force and effect.

PROVIDED, FURTHER, that the said Surety for value received hereby stipulates and agrees that no change, extension of time, alteration or addition to the terms of the contract or to the WORK to be performed thereunder or the SPECIFICATIONS accompanying the same shall in any way affect its obligation on this BOND, and it does hereby waive notice of any such change, extension of time, alteration or addition to the terms of the contract or to the WORK or to the SPECIFICATIONS.

PROVIDED, FURTHER, that no final settlement between the OWNER and the CONTRACTOR shall abridge the right of any beneficiary hereunder, whose claim may be unsatisfied.

IN WITNESS WHEREOF, this instrument is executed in _____ counterparts, each one of which shall be deemed an original, this the _____^(number) day of _____ 20__.

ATTEST:

(Principal Secretary) _____
Principal

(SEAL)

By _____

(Address)

(Address)

Surety

ATTEST:

By _____
Attorney -in-Fact

Witness as to Surety

(Address)

(Address)

NOTE: Date of BOND must not be prior to date of Contract.
If CONTRACTOR is Partnership, all partners should execute BOND.

IMPORTANT: Surety companies executing BONDS must appear on the Treasury Department's most current list (Circular 570 as amended) and be authorized to transact business in the State where the PROJECT is located.

PERFORMANCE BOND

KNOW ALL MEN BY THESE PRESENTS: that

_____ (Name of Contractor)

_____ (Address of Contractor)

a _____, hereinafter called Principal, and
(Corporation, Partnership or Individual)

_____ (Name of Surety)

_____ (Address of Surety)

hereinafter called Surety, are held and firmly bound unto _____

_____ (Name of Owner)

_____ (Address of Owner)

hereinafter called OWNER, in the penal sum of _____ Dollars, \$(_____)

in lawful money of the United States, for the payment of which sum well and truly to be made, we bind ourselves, successors, and assigns, jointly and severally, firmly by these presents.

THE CONDITION OF THIS OBLIGATION is such that whereas, the Principal entered into a certain contract with the OWNER, dated the _____ day of _____ 20 _____, a copy of which is hereto attached and made a part hereof for the construction of:

NOW, THEREFORE, if the Principal shall well, truly and faithfully perform its duties, all the undertakings, covenants, terms, conditions, and agreements of said contract during the original term thereof, and any extensions thereof which may be granted by the OWNER, with or without notice to the Surety and during the one year guaranty period, and if he shall satisfy all claims and demands incurred under such contract, and shall fully indemnify and save harmless the OWNER from all costs and damages which it may suffer by reason of failure to do so, and shall reimburse and repay the OWNER all outlay and expense which the OWNER may incur in making good any default, then this obligation shall be void; otherwise to remain in full force and effect.

PROVIDED, FURTHER, that the said Surety for value received hereby stipulates and agrees that no change, extension of time, alteration or addition to the terms of the contract or to the WORK to be performed thereunder or the SPECIFICATIONS accompanying the same shall in any way affect its obligation on this BOND, and it does hereby waive notice of any such change, extension of time, alteration or addition to the terms of the contract or to the WORK or to the SPECIFICATIONS.

PROVIDED, FURTHER, that no final settlement between the OWNER and the CONTRACTOR shall abridge the right of any beneficiary hereunder, whose claim may be unsatisfied.

IN WITNESS WHEREOF, this instrument is executed in _____ counterparts, each one of which shall be deemed an original, this the _____^(number) day of _____ 20 ____.

ATTEST:

(Principal Secretary) _____
Principal

(SEAL)

By _____

(Address)

(Address)

Surety

ATTEST:

By _____
Attorney -in-Fact

Witness as to Surety

(Address)

(Address)

NOTE: Date of BOND must not be prior to date of Contract.
If CONTRACTOR is Partnership, all partners should execute BOND.

IMPORTANT: Surety companies executing BONDS must appear on the Treasury Department's most current list (Circular 570 as amended) and be authorized to transact business in the State where the PROJECT is located.

NOTICE OF AWARD

To: _____

H-R 860-0683

PROJECT Description: Sanitary Sewer Repair, Two Locations
Cahokia Heights

The OWNER has considered the BID submitted by you for the above described WORK in response to its Advertisement for Bids dated _____, and Information for Bidders.

You are hereby notified that your BID has been accepted for items in the amount of \$ _____

You are required by the Information for Bidders to execute the Agreement and furnish the required CONTRACTOR'S Performance BOND. Payment BOND and certificates of insurance within ten (10) calendar days from the date of this Notice to you.

If you fail to execute said Agreement and to furnish said BONDS within ten (10) days from the date of this Notice, said OWNER will be entitled to consider all your rights arising out of the OWNER'S acceptance of your BID as abandoned and as a forfeiture of your BID BOND. The OWNER will be entitled to such other rights as may be granted by law.

You are required to return an acknowledged copy of this NOTICE OF AWARD to the OWNER.

Dated this _____ day of _____, 20_____.

Cahokia Heights

BY: _____

Title Curtis McCall, Mayor

ACCEPTANCE OF NOTICE

Receipt of the above NOTICE OF AWARD is hereby acknowledged

by _____

this the _____ day of _____, 20_____.

By _____ Title _____

NOTICE TO PROCEED

To: _____

Date: _____

Project: Sanitary Sewer Repair

Two Locations

Cahokia Heights

H-R 860-0683

You are hereby notified to commence WORK in accordance with the Agreement dated _____, 20_____, on or before _____, 20_____, and you are to complete the WORK within 60 consecutive calendar days thereafter. The date of completion of all WORK is therefore _____, 20_____

Cahokia Heights
Owner

By _____
Curtis McCall, Mayor

ACCEPTANCE OF NOTICE

Receipt of the above NOTICE TO PROCEED is hereby acknowledged by

this the _____ day of _____ 20 _____

By _____

Title _____

CHANGE ORDER

Date of Issuance: _____

Change Order No. _____

Project: Sanitary Sewer Repair, Two Locations

Cahokia Heights H-R 860-0683

Owner: Cahokia Heights

Contractor: _____

Engineer: Hurst-Rosche, Inc.

Purpose of Change Order: _____

Description: _____

Original Contract Price: \$ _____ **Original Contract Time:** _____

Adjusted Increase: \$ _____ Adjusted Increase: _____

Adjusted Decrease: \$ _____ Adjusted Decrease: _____

Total Adjusted Contract: \$ _____ Adjusted Contract Time: _____

Requested by: _____ Date: _____
(Contractor/Engineer/Community)

Approved by: _____ Date: _____
(Cahokia Heights) Curtis McCall, Mayor

_____ Date: _____
(Contractor)

_____ Date: _____
(Hurst-Rosche, Inc.)

**NOTICE OF REQUIREMENT FOR AFFIRMATIVE ACTION TO ENSURE EQUAL
EMPLOYMENT OPPORTUNITY
(EXECUTIVE ORDER 11246)**

1. The Offeror's or Bidder's attention is called to the "Equal Opportunity Clause" and the "Standard Federal Equal Employment Opportunity Construction Contract Specifications" set forth herein.
2. The goals and timetables for minority and female participation, expressed in percentage terms for the Contractor's aggregate workforce in each trade on all construction work in the covered area, are as follows:

Timetables	Goals for minority participation for each trade	Goals for female participation in each trade
	Insert goals for* each year <u>14.7%</u>	Insert goals for* each year <u>6.9%</u>

These goals are applicable to all the Contractor's construction work (whether or not it is Federal or federally assisted) performed in the covered area.

The Contractor's compliance with the Executive Order and the regulations in 41 CFR Part 60-4 shall be based on its implementation of the Equal Opportunity Clause, specific affirmative action obligations required by the specifications set forth in 41 CFR 60-4.3(a), and its efforts to meet the goals established for the geographical area where the contract resulting from this solicitation is to be performed. The hours of minority and female employment and training must be substantially uniform throughout the length of the contract, and in each trade, and the contractor shall make a good faith effort to employ minorities and women evenly on each of its projects. The transfer of minority or female employees or trainees from Contractor to Contractor or from project to project for the sole purpose of meeting the Contractor's goals shall be a violation of the contract, the Executive Order and the regulations in 41 CFR 60-4. Compliance with the goals will be measured against the total work hours performed.

3. The Contractor shall provide written notification to the Director of the Office of Federal Contract Compliance Programs within 10 working days of award of any construction subcontract in excess of \$10,000 at any tier for construction work under the contract resulting from this solicitation. The notification shall list the name, address and telephone number of the subcontractor; employer identification number; estimated dollar amount of the subcontract; estimated starting and completion dates of the subcontract; and the geographical area in which the contract is to be performed.
4. As used in this Notice, and in the contract resulting from this solicitation, the "covered area" is **.

*goals and timetables published from time to time by the Director, Office of Federal Contract Compliance Programs (OFCCP)

**Insert description of the geographical areas where the contract is to be performed giving the state, county and city, if any.

**CONSTRUCTION CONTRACTORS AFFIRMATIVE ACTION REQUIREMENTS
GOALS FOR MINORITY PARTICIPATION**

(As published in the Friday, October 3, 1980 Federal Register)

FEMALE PARTICIPATION= 6.9% STATEWIDE

<u>County</u>	<u>Percent</u>	<u>County</u>	<u>Percent</u>	<u>County</u>	<u>Percent</u>
Adams	3.1	Jasper	11.4	Randolph	11.4
Alexander	11.4	Jefferson	11.4	Richland	11.4
Bond	11.4	Jersey	11.4	Rock Island	4.6
Boone	6.3	Jo Davis	0.5	Saline	3.5
Brown	3.1	Johnson	11.4	Sangamon	4.5
Bureau	18.4	Kane	19.6	Schuyler	3.3
Calhoun	11.4	Kankakee	9.1	Scott	4
Carroll	3.4	Kendall	18.4	Shelby	4
Cass	4	Knox	3.3	Stark	3.3
Champaign	7.8	Lake	19.6	St. Clair	14.7
Christian	4	La Salle	18.4	Stephenson	4.6
Clark	2.5	Lawrence	3.5	Tazwell	4.4
Clay	11.4	Lee	4.6	Union	11.4
Clinton	14.7	Livingston	18.4	Vermilion	4.8
Coles	4.8	Logan	4	Wabash	3.5
Cook	19.6	Macon	7.6	Warren	3.3
Crawford	2.5	Macoupin	11.4	Washington	11.4
Cumberland	4.8	Madison	14.7	Wayne	11.4
De Kalb	18.4	Marion	11.4	White	3.5
De Witt	4	Marshall	3.3	Whiteside	3.4
Douglas	4.8	Mason	3.3	Will	20.9
Du Page	19.6	Massac	5.2	Williamson	11.4
Edgar	4.8	McDonough	3.3	Winnebago	6.3
Edwards	3.5	McHenry	19.6	Woodford	4.4
Effingham	11.4	McLean	2.5		
Fayette	11.4	Menard	4.5		
Ford	4.8	Mercer	3.4		
Franklin	11.4	Monroe	14.7		
Fulton	3.3	Montgomery	11.4		
Gallatin	3.5	Morgan	4		
Greene	11.4	Moultrie	4		
Grundy	18.4	Ogle	4.6		
Hamilton	3.5	Peoria	4.4		
Hancock	3.4	Perry	11.4		
Hardin	5.2	Piatt	4.8		
Henderson	3.4	Pike	3.1		
Henry	4.6	Pope	5.2		
Iroquois	18.4	Pulaski	11.4		
Jackson	11.4	Putnam	18.4		

41 CFR 60

60-4.1 Scope and Application.

This part applies to all contractors and subcontractors that hold any Federal or federally assisted construction contract in excess of \$10,000. The regulations in this part are applicable to all of a construction contractor's or subcontractor's construction employees who are engaged in on site construction including those construction employees who work on a non-Federal or non-federally assisted construction site. This part also establishes procedures, which all Federal contracting officers and all applicants, as applicable, shall follow in soliciting for and awarding Federal or federally assisted construction contracts. Procedures also are established which administering agencies shall follow in making any grant, contract, loan, insurance, or guarantee involving federally assisted construction which is not exempt from the requirements of Executive Order 11246, as amended. In addition, this part applies to construction work performed by construction contractors and subcontractors for Federal non-construction contractors and subcontractors if the construction work is necessary in whole or in part to the performance of a non-construction contract or subcontract.

[43 FR 49254, OCT. 20, 1978; 43 FR 51404, NOV. 3, 1978]

60-4.2 Solicitations.

- (a) All Federal contracting officers and all applicants shall include the notice set forth in paragraph (d) of this section and the Standard Federal Equal Employment Opportunity Construction Contract Specifications set forth in § 60-4.3 of this part in all solicitations for offers and bids on all Federal and federally assisted construction contracts or subcontracts to be performed in geographical areas designated by the Director pursuant to § 60-4.6 of the part. Administering agencies shall require the inclusion of the notice set forth in paragraph (d) of this section and the specifications set forth in § 60-4.3 of this part as a condition of any grant, contract, subcontract, loan, insurance or guarantee involving federally assisted construction covered by this Part 60-4.
- (b) All non-construction contractors covered by Executive Order 11246 and the implementing regulations shall include the notice in paragraph (d) of this section in all construction agreements, which are necessary in whole or in part to the performance of the covered non-construction contract.
- (c) Contracting officers, applicants and non-construction contractors shall give written notice to the Director within 10 working days of award of a contract subject to these provisions. The notification shall include the name, address, and telephone number of the contractor; employer identification number; dollar amount of the contract, estimated starting and completion dates of the contract; the contract number; and geographical area in which the contract is to be performed.
- (d) The following notice shall be included in, and shall be a part of, all solicitations for offers and bids on all Federal and federally assisted construction contracts or subcontracts in excess of \$10,000 to be performed in geographical areas designated by the Director pursuant to § 60-4.6 of this part (see 41 CFR 60-4.2(a)):

Notice of Requirement for Affirmative Action to Ensure Equal Employment Opportunity (Executive Order 11246)

1. The Offeror or Bidder's attention is called to the "Equal Opportunity Clause" and the "Standard Federal Equal Employment Specifications" set forth herein.
2. The goals and timetables for minority and female participation, expressed in percentage terms for the Contractor's aggregate workforce in each trade on all construction work in the covered area, are as follows:

Time- tables	Goals for minority participation for each trade	Goals for female participation in each trade
	Insert goals for each year.	Insert goals for each year.

These goals are applicable to all the Contractor's construction work (whether or not it is Federal or federally assisted) performed in the covered area. If the contractor performs construction work in a geographical area located outside of the covered area, it shall apply the goals established for such geographical area where the work is actually performed. With regard to this second area, the contractor also is subject to the goals for both its federally involved and nonfederally involved construction.

The Contractor's compliance with the Executive Order and the regulations in 41 CFR Part 60-4 shall be based on its implementation of the Equal Opportunity Clause, specific affirmative action obligations required by the specifications set forth in 41 CFR 60-4.3(a), and its efforts to meet the goals. The hours of minority and female employment and training must be substantially uniform throughout the length of the contract, and in each trade, and the contractor shall make a good faith effort to employ minorities and women evenly on each of its projects. The transfer of minority or female employees or trainees from Contractor to Contractor or from project to project for the sole purpose of meeting the Contractor's goals shall be a violation of the contract, the Executive Order and the regulations in 41 CFR Part 60-4. Compliance with the goals will be measured against the total work hours performed.

3. The Contractor shall provide written notification to the Director of the Office of Federal Contract Compliance Programs within 10 working days of award of any construction subcontract in excess of \$10,000 at any tier for construction work under the contract resulting from this solicitation. The notification shall list the name, address and telephone number of the subcontractor; employer identification number of the subcontractor; estimated dollar amount of the subcontract; estimated starting and completion dates of the subcontract; and the geographical area in which the subcontract is to be performed.
4. As used in this Notice, and in the contract resulting from this solicitation, the "covered area" is (insert description of the geographical areas where the contract is to be performed giving the state, county, and city, if any).

[43 FR 49254, OCT. 20, 1978; 43 FR 51401, NOV. 3, 1978, AS AMENDED AT 45 FR 65977, OCT. 3, 1980]

60-4.3 Equal Opportunity Clauses.

(a) The equal opportunity clause published at 41 CFR 60-1.4(a) of this chapter is required to be included in, and is part of, all nonexempt Federal contracts and subcontracts, including construction contracts and subcontracts. The equal opportunity clause published at 41 CFR 60-1.4(b) is required to be included in, and is a part of, all nonexempt federally assisted construction contracts and subcontracts. In addition to the clauses described above, all Federal contracting officers, all applicants and all non-construction contractors, as applicable, shall include the specifications set forth in this section in all Federal and federally assisted construction contracts in excess of \$10,000 to be performed in geographical areas designated by the Director pursuant to § 60-4.6 of this part and in construction subcontracts in excess of \$10,000 necessary in whole or in part to the performance of non-construction Federal contracts and subcontracts covered under the Executive order.

Standard Federal Equal Employment Opportunity Construction Contract Specifications (Executive Order 11246)

1. As used in these specifications:

a. "Covered area," means the geographical area described in the solicitation from which this contract resulted:

b. "Director" means Director, Office of Federal Contract Compliance Programs, United States Department of Labor, or any person to whom the Director delegates authority;

c. "Employer identification number" means the Federal Social Security number used on the Employer's Quarterly Federal Tax Return, U.S. Treasury Department Form 941.

d. "Minority" includes:

(i) Black (all persons having origins in any of the Black African racial groups not of Hispanic origin);

(ii) Hispanic (all persons of Mexican, Puerto Rican, Cuban, Central or South American or other Spanish Culture or origin, regardless of race);

(iii) Asian and Pacific Islander (all persons having origins in any of the original peoples of the Far East, Southeast Asia, the Indian Subcontinent, or the Pacific Islands); and

(iv) American Indian or Alaskan Native (all persons having origins in any of the original peoples of North America and maintaining identifiable tribal affiliations through membership and participation or community identification).

2. Whenever the Contractor, or any Subcontractor at any tier, subcontracts a portion of the work involving any construction trade, it shall physically include in each subcontract in excess of \$10,000 the provisions of these specifications and the Notice which contains the applicable goals

for minority and female participation and which is set forth in the solicitations from which this contract resulted.

3. If the Contractor is participating (pursuant to 41 CFR 60-4.5) in a Hometown Plan approved by the U.S. Department of Labor in the covered area either individually or through an association, its affirmative action obligations on all work in the Plan area (including goals and timetables) shall be in accordance with that Plan for those trades which have unions participating in the Plan. Contractors must be able to demonstrate their participation in and compliance with the provisions of any such Hometown Plan. Each Contractor or Subcontractor participating in an approved Plan is individually required to comply with its obligations under the EEO clause, and to make a good faith effort to achieve each goal under the Plan in each trade in which it has employees. The overall good faith performance by other Contractors or Subcontractors toward a goal in an approved Plan does not excuse any covered Contractor or Subcontractor's failure to take good faith efforts to achieve the Plan goals and timetables.
4. The Contractor shall implement the specific affirmative action standards provided in paragraphs 7 a through p of these specifications. The goals set forth in the solicitation from which this contract resulted are expressed as percentages of the total hours of employment and training of minority and female utilization the Contractor should reasonably be able to achieve in each construction trade in which it has employees in the covered area. Covered Construction contractors performing construction work in geographical areas where they do not have a Federal or federally assisted construction contract shall apply the minority and female goals established for the geographical area where the work is being performed. Goals are published periodically in the Federal Register in notice form, and such notices may be obtained from any Office of Federal Contract Compliance Programs office or from Federal procurement contracting officers. The Contractor is expected to make substantially uniform progress in meeting its goals in each craft during the period specified.
5. Neither the provisions of any collective bargaining agreement, nor the failure by a union with whom the Contractor has a collective bargaining agreement, to refer either minorities or women shall excuse the Contractor's obligations under these specifications, Executive Order 11246, nor the regulations promulgated pursuant thereto.
6. In order for the nonworking training hours of apprentices and trainees to be counted in meeting the goals, the Contractor must employ such apprentices and trainees during the training period, and the Contractor must have made a commitment to employ the apprentices and trainees at the completion of their training, subject to the availability of employment opportunities. Trainees must be trained pursuant to training programs approved by the U.S. Department of Labor.
7. The Contractor shall take specific affirmative action to ensure equal employment opportunity. The evaluation of the Contractor's compliance with these specifications shall be based upon its effort to achieve maximum results from its actions. The Contractor shall document these efforts fully, and shall implement affirmative action steps at least as extensive as the following:
 - a. Ensure and maintain a working environment free of harassment, intimidation, and coercion at all sites, and in all facilities at which the Contractor's employees are assigned to work. The Contractor, where possible, will assign two or more women to each construction project. The

Contractor shall specifically ensure that all foremen, superintendents, and other on-site supervisory personnel are aware of and carry out the Contractor's obligation to maintain such a working environment, with specific attention to minority or female individuals working at such sites or in such facilities.

- b.** Establish and maintain a current list of minority and female recruitment sources, provide written notification to minority and female recruitment sources and to community organizations when the Contractor or its unions have employment opportunities available, and maintain a record of the organizations' responses.
- c.** Maintain a current file of the names, addresses and telephone numbers of each minority and female off-the-street applicant and minority or female referral from a union, a recruitment source or community organization and of what action was taken with respect to each such individual. If such individual was sent to the union hiring hall for referral and was not referred back to the Contractor by the union or, if referred, not employed by the Contractor, this shall be documented in the file with the reason; therefore, along with whatever additional actions the Contractor may have taken.
- d.** Provide immediate written notification to the Director when the union or unions with which the Contractor has a collective bargaining agreement has not referred to the Contractor a minority person or woman sent by the Contractor, or when the Contractor has other information that the union referral process has impeded the Contractor's efforts to meet its obligations.
- e.** Develop on-the-job training opportunities and/or participate in training programs for the area which expressly include minorities and women, including upgrading programs and apprenticeship and trainee programs relevant to the Contractor's employment needs, especially those programs funded or approved by the Department of Labor. The Contractor shall provide notice of these programs to the sources compiled under 7b above.
- f.** Disseminate the Contractor's EEO policy by providing notice of the policy to unions and training programs and requesting their cooperation in assisting the Contractor in meeting its EEO obligations; by including it in any policy manual and collective bargaining agreement; by publicizing it in the company newspaper, annual report, etc.; by specific review of the policy with all management personnel and with all minority and female employees at least once a year; and by posting the company EEO policy on bulletin boards accessible to all employees at each location where construction work is performed.
- g.** Review, at least annually, the company's EEO policy and affirmative action obligations under these specifications with all employees having any responsibility for hiring, assignment, layoff, termination, or other employment decisions including specific review of these items with onsite supervisory personnel such as Superintendents, General Foremen, etc., prior to the initiation of construction work at any job site. A written record shall be made and maintained identifying the time and place of these meetings, persons attending, subject matter discussed, and disposition of the subject matter.
- h.** Disseminate the Contractor's EEO policy externally by including it in any advertising in the news media, specifically including minority and female news media, and providing written

notification to and discussing the Contractor's EEO policy with other Contractors and Subcontractors with whom the Contractor does or anticipates doing business.

i. Direct its recruitment efforts, both oral and written, to minority, female and community organizations, to schools with minority and female students and to minority and female recruitment and training organizations serving the Contractor's recruitment area and employment needs. Not later than one month prior to the date for the acceptance of applications for apprenticeship or other training by any recruitment source, the Contractor shall send written notification to organizations such as the above, describing the openings, screening procedures, and tests to be used in the selection process.

j. Encourage present minority and female employees to recruit other minority persons and women and, where reasonable, provide after school, summer and vacation employment to minority and female youth both on the site and in other areas of a contractor's work force.

k. Validate all tests and other selection requirements where there is an obligation to do so under 41 CFR Part 60-3.

l. Conduct, at least annually, an inventory and evaluation at least of all minority and female personnel for promotional opportunities and encourage these employees to seek or to prepare for, through appropriate training, etc., such opportunities.

m. Ensure that seniority practices, job classifications, work assignments and other personnel practices, do not have a discriminatory effect by continually monitoring all personnel and employment related activities to ensure that the EEO policy and the Contractor's obligations under these specifications are being carried out.

n. Ensure that all facilities and company activities are non-segregated except that separate or single-user toilet and necessary changing facilities shall be provided to assure privacy between the sexes.

o. Document and maintain a record of all solicitations of offers for subcontracts from minority and female construction contractors and suppliers, including circulation of solicitations to minority and female contractor associations and other business associations.

p. Conduct a review, at least annually, of all supervisors' adherence to and performance under the Contractor's EEO policies and affirmative action obligations.

8. Contractors are encouraged to participate in voluntary associations, which assist in fulfilling one or more of their affirmative action obligations (7a through p). The efforts of a contractor association, joint contractor-union, contractor-community, or other similar group of which the contractor is a member and participant, may be asserted as fulfilling any one or more of its obligations under 7a through p of these Specifications provided that the contractor actively participates in the group, makes every effort to assure that the group has a positive impact on the employment of minorities and women in the industry, ensures that the concrete benefits of the program are reflected in the Contractor's minority and female workforce participation, makes a good faith effort to meet its individual goals and timetables, and can provide access to documentation which demonstrates the effectiveness of actions taken on behalf of the

Contractor. The obligation to comply, however, is the Contractor's and failure of such a group to fulfill an obligation shall not be a defense for the Contractor's noncompliance.

9. A single goal for minorities and a separate single goal for women have been established. The Contractor, however, is required to provide equal employment opportunity and to take affirmative action for all minority groups, both male and female, and all women, both minority and non-minority. Consequently, the Contractor may be in violation of the Executive Order if a particular group is employed in a substantially disparate manner (for example, even though the Contractor has achieved its goals for women generally, the Contractor may be in violation of the Executive Order if a specific minority group of women is underutilized).

10. The Contractor shall not use the goals and timetables or affirmative action standards to discriminate against any person because of race, color, religion, sex, or national origin.

11. The Contractor shall not enter into any Subcontract with any person or firm debarred from Government contracts pursuant to Executive Order 11246.

12. The Contractor shall carry out such sanctions and penalties for violation of these specifications and of the Equal Opportunity Clause, including suspension, termination and cancellation of existing subcontracts as may be imposed or ordered pursuant to Executive Order 11246, as amended, and its implementing regulations, by the Office of Federal Contract Compliance Programs. Any Contractor who fails to carry out such sanctions and penalties shall be in violation of these specifications and Executive Order 11246, as amended.

13. The Contractor, in fulfilling its obligations under these specifications, shall implement specific affirmative action steps, at least as extensive as those standards prescribed in paragraph 7 of these specifications, so as to achieve maximum results from its efforts to ensure equal employment opportunity. If the Contractor fails to comply with the requirements of the Executive Order, the implementing regulations, or these specifications, the Director shall proceed in accordance with 41 CFR 60-4.8.

14. The Contractor shall designate a responsible official to monitor all employment related activity to ensure that the company EEO policy is being carried out, to submit reports relating to the provisions hereof as may be required by the Government and to keep records. Records shall at least include for each employee the name, address, telephone numbers, construction trade, union affiliation if any, employee identification number when assigned, social security number, race, sex, status (e.g., mechanic, apprentice trainee, helper, or laborer), dates of changes in status, hours worked per week in the indicated trade, rate of pay, and locations at which the work was performed. Records shall be maintained in an easily understandable and retrievable form; however, to the degree that existing records satisfy this requirement, contractors shall not be required to maintain separate records.

15. Nothing herein provided shall be construed as a limitation upon the application of other laws, which establish different standards of compliance or upon the application of requirements for the hiring of local or other area residents (e.g., those under the Public Works Employment Act of 1977 and the Community Development Block Grant Program).

(b) The notice set forth in 41 CFR 60-4.2 and the specifications set forth in 41 CFR 60-4.3 replace the New Form for Federal Equal Employment Opportunity Bid Conditions for Federal and Federally Assisted Construction published at 41 FR 32482 and commonly known as the Model Federal EEO Bid Conditions, and the New Form shall not be used after the regulations in 41 CFR Part 60-4 become effective.

[43 FR 49254, OCT. 20, 1978; 43 FR 51401, NOV. 3, 1978, AS AMENDED AT 45 FR 65978, OCT. 3, 1980]

60-4.4 Affirmative Action Requirements.

(a) To implement the affirmative action requirements of Executive Order 11246 in the construction industry, the Office of Federal Contract Compliance Programs previously has approved affirmative action programs commonly referred to as "Hometown Plans," has promulgated affirmative action plans referred to as "Imposed Plans" and has approved "Special Bid Conditions" for high impact projects constructed in areas not covered by a Hometown or an Imposed Plan. All solicitations for construction contracts made after the effective date of the regulations in this part shall include the notice specified in § 60-4.2 of this part and the specifications in § 60-4.3 of this part in lieu of the Hometown and Imposed Plans including the Philadelphia Plan and Special Bid Conditions. Until the Director has issued an order pursuant to § 60-4.6 of this part establishing goals and timetables for minorities in the appropriate geographical areas or for a project covered by Special Bid Conditions, the goals and timetables for minorities to be inserted in the Notice required by 41 CFR 60-4.2 shall be the goals and timetables contained in the Hometown Plan, Imposed Plan or Special Bid Conditions presently covering the respective geographical area or project involved.

(b) Signatories to a Hometown Plan (including heavy highway affirmative action plans) shall have 45 days from the effective date of the regulations in this part to submit under such a Plan (for the director's approval) goals and timetables for women and to include female representation on the Hometown Plan Administrative Committee. Such goals for female representation shall be at least as high as the goals established for female representation in the notice issued pursuant to 41 CFR 60-4.6. Failure of the signatories, within the 45-day period, to include female representation and to submit goals for women or a new plan, as appropriate, shall result in an automatic termination of the Office of Federal Contract Compliance Program's approval of the Hometown Plan. At any time, the Office of Federal Contract Compliance Programs terminates or withdraws its approval of a Hometown Plan, or when the plan expires and another plan is not approved, the contractors signatory to the plan shall be covered automatically by the specifications set forth in § 60-4.3 of this part and by the goals and timetables established for that geographical area pursuant to § 60-4.6 of this part.

60-4.5 Hometown Plans

(a) A contractor participating, either individually or through an association, in an approved Hometown Plan (including heavy highway affirmative action plans) shall comply with its affirmative action obligations under Executive Order 11246 by complying with its obligations under the plan: *Provided*, That each contractor or subcontractor participating in an approved plan is individually required to comply with the equal opportunity clause set forth in 41 CFR 60-1.4; to make a good faith effort to achieve the goals for each trade participating in the plan in which it

has employees; and that the overall good performance by other contractors or subcontractors toward a goal in an approved plan does not excuse any covered contractor's or subcontractor's failure to take good faith efforts to achieve the plan's goals and timetables. If a contractor is not participating in an approved Hometown Plan it shall comply with the specifications set forth in § 60-4.3 of this part and with the goals and timetables for the appropriate area as listed in the notice required by 41 CFR 60-4.2 about that trade. For the purposes of this part 60-4, a contractor is not participating in a Hometown Plan for a particular trade if it:

- (1) Ceases to be signatory to a Hometown Plan covering that trade;
 - (2) Is signatory to a Hometown Plan for that trade but is not party to a collective bargaining agreement for that trade;
 - (3) Is signatory to a Hometown Plan for that trade but is party to a collective bargaining agreement with labor organizations, which are not or cease to be signatories to the same Hometown Plan for that trade;
 - (4) Is signatory to a Hometown Plan for that trade but is party to a collective bargaining agreement with a labor organization for that trade but the two have not jointly executed a specific commitment to minority and female goals and timetables and incorporated the commitment in the Hometown Plan for that trade;
 - (5) Is participating in a Hometown Plan for that trade which is no longer acceptable to the Office of Federal Contract Compliance Programs;
 - (6) Is signatory to a Hometown Plan for that trade but is party to a collective bargaining agreement with a labor organization for that trade and the labor organization and the contractor have failed to make a good faith effort to comply with their obligations under the Hometown Plan for that trade.
- (b) Contractors participating in Hometown Plans must be able to demonstrate their participation and document their compliance with the provision of the Hometown Plan.

[43 FR 49254, OCT. 20, 1978; 43 FR 51401, NOV. 3, 1978]

60-4.6 Goals and Timetables.

The Director, from time to time, shall issue goals and timetables for minority and female utilization, which shall be based on appropriate workforce, demographic, or other relevant data and which shall cover construction projects or construction contracts performed in specific geographical areas. The goals, which shall be applicable to each construction trade in a covered contractor's or subcontractor's entire workforce which is working in the area covered by the goals and timetables, shall be published as notices in the Federal Register, and shall be inserted by the contracting officers and applicants, as applicable, in the Notice required by 41 CFR 60-4.2. Covered construction contractors performing construction work in geographical areas where they do not have a Federal or federally assisted construction contract shall apply the minority and female goals established for the geographical area where the work is being performed.

[45 FR 65978, OCT. 3, 1980]

60-4.7 Effect on Other Regulations.

The regulations in this part are in addition to the regulations contained in this chapter, which apply to construction contractors and subcontractors generally. See particularly, 41 CFR 60-1.4 (a), (b), (c), (d), and (e); 60-1.5; 60-1.7; 60-1.8; 60-1.26; 60-1.29; 60-1.30; 60-1.32; 60-1.41; 60-1.42; 60-1.43; and 41 CFR Part 60-3; Part 60-20; Part 60-30; Part 60-40; and Part 60-50.

60-4.8 Show Cause Notice.

If an investigation or compliance review reveals that a construction contractor or subcontractor has violated the Executive order, any contract clause, specifications or the regulations in this chapter and if administrative enforcement is contemplated, the Director shall issue to the contractor or subcontractor a notice to show cause which shall contain the items specified in paragraphs (i) through (iv) of 41 CFR 60-2.2(c)(1). If the contractor does not show good cause within 30 days, or in the alternative, fails to enter an acceptable conciliation agreement which includes where appropriate, make up goals and timetables, back pay, and seniority relief for affected class members, the OFCCP shall follow the procedure in 41 CFR 60-1.26(b): *Provided*, That where a conciliation agreement has been violated, no show cause notice is required prior to the initiation of enforcement proceedings.

[43 FR 49254, OCT. 20, 1978; 43 FR 51401, NOV. 3, 1978]

60-4.9 Incorporation by Operation of the Order.

By operation of the order, the equal opportunity clause contained in § 60-1.4, the Notice of Requirement for Affirmative Action to Ensure Equal Employment Opportunity (Executive Order 11246) contained in § 60-4.2, and the Standard Federal Equal Employment Opportunity Construction Contract Specifications (Executive Order 11246) contained in § 60-4.3 shall be deemed to be a part of every solicitation or of every contract and subcontract, as appropriate, required by the order and the regulations in this chapter to include such clauses whether or not they are physically incorporated in such solicitation or contract and whether or not the contract is written.

NOTICE TO LABOR UNIONS OR OTHER ORGANIZATIONS OF WORKERS
NONDISCRIMINATION IN EMPLOYMENT

To: _____
(Name of union or organization of workers)

The undersigned currently holds contract(s) with _____
(name of applicant)

involving funds or credit of the U.S. Government or (a) subcontract(s) with a prime contractor holding such contract(s).

You are advised that under the provisions of the above contracts(s) or subcontract(s) and in accordance with Executive Order 11246, as amended, dated September 24, 1965, as amended, the undersigned is obliged not to discriminate against any employee or applicant for employment because of race, color, creed or national origin. This obligation not to discriminate in employment includes, but is not limited to, the following:

HIRING, PLACEMENT, UPGRADING, TRANSFER OR DEMOTION, RECRUITMENT,
ADVERTISING, OR SOLICITATION FOR EMPLOYMENT, TRAINING DURING
EMPLOYMENT, RATES OF PAY OR OTHER FORMS OF COMPENSATION, SELECTION
FOR TRAINING INCLUDING APPRENTICESHIP, LAYOFF OR TERMINATION.

This notice is furnished you pursuant to the provisions of the above contract(s) or subcontracts(s) and Executive Order 11246, as amended.

Copies of this notice will be posted by the undersigned in conspicuous places available to employees or applicants for employment.

(Contractor or Subcontractor)

(Date)

EPA Project Control #: _____

United States Environmental Protection Agency
Washington, DC 20460

Certification Regarding Debarment, Suspension and Other Responsibility Matters

The prospective participant to the best of its knowledge and belief that it and its principles:

- (a) Are not presently debarred, suspended, proposed for debarment, declared ineligible, or voluntarily excluded from covered transactions by any Federal department or agency;
- (b) Have not within a three year period preceding this proposal been convicted of or had a civil judgment rendered against them for commission of fraud or a criminal offense in connection with obtaining, attempting to obtain, or performing a public (Federal, State or local) transaction or contract under a public transaction; violation of Federal or State antitrust statutes or commission of embezzlement, theft, forgery, bribery, falsification or destruction of records, making false statements, or receiving stolen property.
- (c) Are not presently indicted for or otherwise criminally or civilly charged by a government entity (Federal, State or local) with commission of any of the offenses enumerated in paragraph (1) (b) of this certification; and
- (d) Have not within a three-year period preceding this application/proposal had one or more public transactions (Federal, State or local) terminated for cause or default.

I understand that a false statement on this certification may be grounds for rejection of this proposal or termination of the award. In addition, under 18 USC Sec. 1001, a false statement may result in fine of up to \$10,000 or imprisonment for up to 5 years, or both.

(Typed Name & Title of Authorized Representative)

(Signature of Authorized Representative) (Date)

I am unable to certify the above statements. My explanation is attached.

Instructions

Under Executive Order 12549 an individual or organization debarred or excluded from participation in Federal assistance or benefit programs may not receive any assistance award under a federal program, or a sub-agreement thereunder for \$25,000 or more.

Accordingly, each prospective recipient of an EPA grant, loan, or cooperative agreement and any contract or sub-agreement participant thereunder must complete the attached certification or provide an explanation why they cannot. For further details, see 40 CFR 32.510, Participants' responsibilities, in the attached regulation.

Where to Submit

The prospective EPA grant, loan, or cooperative agreement recipient must return the signed certification or explanation with its application to the appropriate EPA Headquarters or Regional office, as required in the application instructions.

A prospective prime contractor must submit a completed certification or explanation to the individual or organization awarding the contract.

Each prospective subcontractor must submit a completed certification or explanation to the prime contractor for the project.

How to Obtain Forms:

EPA includes the certification form, instructions, and a copy of its implementing regulation (40 CFR Part 32) in each application kit. Applicants may reproduce these materials as needed and provide them to their prospective prime contractor, who, in turn, may reproduce and provide them to prospective subcontractors.

Additional copies/assistance may be requested from:

Compliance Branch
Grants Administration Division (PM-216F)
U.S. Environmental Protection Agency
401 M Street, SW
Washington DC 20460
(Telephone: 202-475-8025)

**Construction Contracts of Loan Recipient and Other Sections From
"Procedures for Issuing Loans from the Water Pollution Control Loan Program"**

Section 365.420(b)(2) Change Orders

- A) When the loan recipient authorizes the contractor to add, delete, or revise the work within the general scope of the contract documents, or authorizes an adjustment in the contract price or contract time, the loan recipient shall submit a change order to the Agency.
- B) For each change order, the loan recipient shall submit to the Agency for approval the following documentation:
 - i) one copy of the fully executed change order signed by the loan recipient, construction engineer, and the contractor; and
 - ii) a description of any changes, with justification for the changes.
- C) Prior approval by the Agency of a change order is required when a change order results in:
 - i) alterations in design scope that require a modification to a construction permit; or
 - ii) an increase in the amount of loan funds needed to complete the project.
- D) Failure to give timely notice of proposed project changes or action by the loan recipient that is not consistent with the Agency's determination on those changes may result in disallowance of loan participation for costs incurred that are attributable to the change.

Section 365.620(f) Required Construction Contract Provisions

Each construction contract shall include the following provisions:

- 1) Audit; access to records:
 - A) The contractor shall maintain books, records, documents and other evidence directly pertinent to performance on loan work in accordance with Generally Accepted Accounting Principles (GAAP). The contractor shall also maintain the financial information and data used by the contractor in the preparation or support of any cost submissions required under Section 365.420 (b)(2) of the loan rules and a copy of the cost summary submitted to the owner. The Illinois Auditor General, the owner, the Agency, or any of their authorized representatives shall have access to the books, records, papers, documents, and other evidence for purposes of inspection, audit, examination, excerpts, transcriptions, and copying. The contractor shall provide facilities for access and inspection.
 - B) For a formally advertised, competitively awarded, fixed price contract, the contractor shall include access to records as required by subsection (a)(1)(A) of the loan rules for

all negotiated change orders and contract amendments in excess of \$25,000 that affect the contract price. In the case of all other prime contracts, the contractor shall agree to include access to records required by subsection (a)(1)(A) in all contracts and all tier subcontracts or change orders in excess of \$25,000 that are directly related to project performance.

- C) Audits shall be in accordance with auditing standards generally accepted in the United States.
- D) The contractor shall agree to the disclosure of all information and reports resulting from access to records required by subsection (a)(1)(A). When the audit concerns the contractor, the auditing agency shall afford the contractor an opportunity for an audit exit conference and an opportunity to comment on the pertinent portions of the draft audit report. The final audit report shall include the written comments, if any, of the audited parties.
- E) The records required by subsection (a)(1)(A) shall be maintained and made available during performance of the work under the loan agreement and for 3 years after the date of the final loan audit. In addition, records that relate to any dispute or litigation or the settlement of claims arising out of any performance, costs or items to which an audit exception has been taken, shall be maintained and made available for 3 years after resolution of the dispute, appeal, litigation, claim or exception.
- F) The right of access will generally be exercised with respect to financial records under:
 - i) Negotiated prime contracts;
 - ii) Negotiated change orders or contract amendments in excess of \$25,000 affecting the price of any formally advertised, competitively awarded, fixed price contract; and
 - iii) Subcontracts or purchase orders under any contract other than a formally advertised, competitively awarded, fixed price contract.
- G) The right of access will generally not be exercised with respect to a prime contract, subcontract, or purchase order awarded after effective price competition. In any event, the right of access shall be exercised under any type of contract or subcontract:
 - i) With respect to records pertaining directly to contract performance, excluding any financial records of the contractor; and
 - ii) If there is any indication that fraud, gross abuse, or corrupt practices may be involved in the award or performance of the contract or subcontract.

2) Covenant against contingent fees.

The contractor shall warrant that no person or selling agency has been employed or retained to solicit or secure the contract upon an agreement or understanding for a commission, percentage, brokerage, or contingent fee. For breach or violation of this warranty, the owner shall have the right to annul the contract without liability or in its discretion to deduct from the contract price or consideration, or otherwise recover, the full amount of such commission, percentage, brokerage, or contingent fee.

3) Wage provisions.

The Contractor shall pay prevailing wages in accordance with the Davis-Bacon Act (40 USC 3141 through 3148) as defined by the U.S. Department of Labor.

4) Disadvantaged business enterprise requirements.

The contractor shall provide evidence that the contractor has taken affirmative steps in accordance with 40 CFR 33 to assure that disadvantaged business enterprises are used when possible as sources of supplies, equipment, construction, and services, consistent with the provisions of the Agency's Operating Agreement with USEPA.

5) Debarment and suspension provisions.

The contract shall require the successful bidders to submit a Certificate Regarding Debarment, Suspension and Other Responsibility Matters (EPA Form 5700-49) showing compliance with federal Executive Order 12549.

6) Nonsegregated facilities provisions

The contractor shall be required to submit a Certification of Nonsegregated Facilities on forms provided by the Agency.

7) American Iron and Steel

The contractor shall be required to use American Iron and Steel, if required by USEPA for that fiscal year.

8) A clause that provides:

"No contractor or subcontractor shall discriminate on the basis of race, color, national origin or sex in the performance of this contract. The contractor or subcontractor shall carry out applicable requirements of 40 CFR 33 in the award and administration of contracts awarded under the WPCLP. Failure by the contractor or subcontractor to carry out these requirements is a material breach of this contract which may result in the termination of this contract or other legally available remedies."

Section 365.620(g) Subcontracts Under Construction Contracts

The award or execution of all subcontracts by a prime contractor and the procurement and negotiation procedures used by the prime contractor shall comply with:

- 1) All applicable provisions of federal, State and local law;
- 2) All provisions of Part 365 regarding fraud and other unlawful or corrupt practices;
- 3) All provisions of Part 365 with respect to access to facilities, records and audit of records; and
- 4) All provisions of subsection 365.620(f)(5) that require a Certification Regarding Debarment, Suspension, and Other Responsibility Matters (EPA Form 5700-49) showing compliance with any controlling federal Executive Orders.

Section 365.620(h) Contractor Bankruptcy

In the event of a contractor bankruptcy, the loan recipient shall notify the Agency and shall keep the Agency advised of any negotiations with the bonding company, including any proposed settlement. The Agency may participate in those negotiations and will advise the loan recipient of the impact of any proposed settlement to the loan agreement. The loan recipient shall be responsible for assuring that every appropriate procedure and incidental legal requirement is observed in advertising for bids and re-awarding a construction contract.

Section 365.620(i) Access

Every contract entered by the loan recipient for construction work, and every subagreement, shall provide the Agency representatives with access to the work. The contractor or subcontractor shall provide facilities for such access and inspection.

Section 365.640(c) Remedies

All claims, counter-claims, disputes and other matters in question between the recipient and the contractor arising out of, or relating to, a subagreement or its breach shall be decided by arbitration if the parties agree, or in a court of competent jurisdiction within the State.

Bidder Certification
In Compliance with Article 33E-11 to the
"Criminal Code of 2012"

I _____, do hereby certify that:
Name

1. I am _____ of the _____
Position Firm
and have authority to execute this certification on behalf of the firm

2. This firm is not barred from bidding on this contract due to either a Bid-rigging or Bid Rotating violation as set forth in Article 33E-11 to the "Illinois Criminal Code of 2012 [720 ILCS 5/33E-11]"

Name of Firm _____

Signature _____

Title _____

Date _____

Corporate Seal (where appropriate)

On this _____ day of _____ 20____, before me appeared (Name)

_____ to me personally known, who, being duly sworn, did execute the foregoing affidavit, and did state that he or she was properly authorized by (Name of Firm) _____ to execute the affidavit and did so as his or her free act and deed.

Notary Public _____ Commission Expires _____

Notary Seal

Specifications for Disadvantaged Business Enterprise Participation

(Name of Loan Recipient) _____

I. Disadvantaged Business Enterprise Policy

- A. It is the policy of the State of Illinois to award a fair share of sub-agreements to disadvantaged businesses (DBEs). In complying with this requirement, contractors are required to take affirmative steps to assure that disadvantaged businesses are used when possible as sources of supplies, equipment, construction, and services as explained herein.
- B. These specifications define the terms, conditions, and requirements of the State Revolving Fund Loan Program, and the (Name of Loan Recipient) _____'s policy and procedures for complying with these requirements.
- C. As required by the award conditions of USEPA's Assistance Agreement with IEPA, the fair share percentages are 5% for MBEs and 12% for WBEs.

II. Pre-Contract Award Obligations

- A. All bidders are required to advertise subcontracting opportunities and to negotiate with disadvantaged businesses prior to bid opening. Failure to document such affirmative efforts shall be deemed, relative to disadvantaged business compliance, non-responsive.
- B. To establish a bid as responsible, the bidder will be required to document the proposed utilization of disadvantaged businesses with letters of intent signed by the bidder and by the disadvantaged business listed in the bid. The documentation requirements are outlined in Section III of this document.
- C. (Name of Loan Recipient) _____'s disadvantaged business policy clearly intends for bidders to contact and encourage the participation of disadvantaged businesses prior to bid opening. Affirmative efforts (the written record of conscientious and honest communications between the bidder and disadvantaged business) must be initiated and completed by the bidder prior to bid opening. All bidders must document compliance with the requirements of the disadvantaged business policy.

III. Evaluation of Disadvantaged Business Utilization and Affirmative Efforts

- A. As a prerequisite to demonstrate compliance with the (Name of Loan Recipient) _____'s disadvantaged business policy, ALL bidders shall provide the following with its bid:
 - 1. Completed and signed certification from the bidder(s), attesting that the bidder will award no sub-agreements, including the procurement of equipment, materials, supplies and services, in the performance of this contract.

OR

2. "Certification of publication," or adequate proof of publication, including an actual copy of the newspaper advertisement from a daily newspaper. **The advertisement must run one day at least (16) days prior to bid opening.** An example advertisement follows this section.

Bidders may publish the advertisement in an established, online bidder's clearinghouse such as the "Dodge Report (<http://construction.com/dodge/>)". If an online advertisement is placed with the "Dodge Report" or an equivalent website, a screenshot of the advertisement along with the webpage address, and a payment receipt is required as documentation. **The advertisement must run one day at least (16) days prior to bid opening.**

3. List of all disadvantaged business enterprise (DBE) and non-DBE's that submitted proposals to the bidder along with the date of the proposal. Names, addresses, phone number and/or e-mail are required.
4. List of disadvantaged businesses not being utilized and justification for non-utilization.
5. If DBE subcontractors will be utilized for the project, a completed and signed copy of IEPA DBE Form No. 3 (DBE Subcontractor Utilization Form) or an equivalent "Notice of Intent" is needed from each subcontractor.
6. If DBE subcontractors will be utilized for the project, a completed and signed certification from the bidder(s), attesting that the bidder has no controlling or dominating interest or conflict of interest with the disadvantaged business that will be utilized.
7. In instances where the bidder(s) does not receive any proposals from disadvantaged businesses prior to bid opening, the bidder(s) must provide a written certification attesting that no proposals were received.

Failure to submit the documentation pursuant to the requirements of A (1-7) above may cause rejection of the bid as non-responsive.

IV. Sanctions

- A. The (Name of Loan Recipient) _____ may reject one or all bids when the information submitted by the bidder(s) fails to demonstrate compliance with the disadvantaged business requirements (i.e., the bidder fails to place their pre-bid advertisement in a daily newspaper, or approved website, at least 16 days prior to bid opening).
- B. Upon finding that any Party has not complied with the requirements of these specifications, including misrepresenting a firm as a disadvantaged business, any one or a combination of the following actions may be taken.
 1. Declare the bidder and/or subcontractor non-responsive and therefore, ineligible for contract award.
 2. Disallow all contract costs associated with non-compliance.

3. Refer matters which may be fraudulent to the Illinois Attorney General.

V. Post-Contract Award Compliance

- A. As required by the award conditions of USEPA's Assistance Agreement with IEPA, all sub-agreements of the prime contractor must identify that the fair share percentages are 5% for MBEs and 12 % for WBEs.
- B. After award of the prime contract, copies of all disadvantaged business-related sub-agreements between the prime contractor and subcontractors shall be submitted to the owner.
- C. After bid submission, any changes in previously reported disadvantaged businesses utilization shall be handled in accordance with 40 CFR Part 33.302(b-h). If the contractor fails to initiate such actions, the owner may withhold payments and/or institute other appropriate sanctions.

**Suggested Disadvantaged Business (DBE)
Advertisement for Construction Contractors**

Notice to Disadvantaged Businesses

_____, _____, _____, is
(Name of Company) (Address of Company) (Telephone)

seeking disadvantaged businesses for the _____
(Name of Loan Recipient)

Project for subcontracting opportunities in the following areas: _____,
_____, _____

All disadvantaged businesses should contact, IN WRITING, (certified letter, return receipt requested),
_____ to discuss the subcontracting opportunities. All negotiations must
(Company Contact Person)

be completed prior to bid opening _____.
(Date of Bid Opening)

*The advertisement must clearly state the method of evaluating the proposals or quotations, and the relative importance attached to each criterion. Bidders must uniformly and objectively evaluate the proposals submitted by disadvantaged business in response to the advertisement based upon the evaluation criteria stated in the advertisement. The evaluation criteria must not be restrictive or exclusionary.

Summary Report of Disadvantaged Business Enterprise Requirements for Contractors

- 1) Completed and signed certification from bidder(s), attesting that the bidder will award no sub-agreements, including the procurement of equipment, materials, supplies and services in the performance of this contract (may use IEPA DBE Form #1).

OR

"Certificate of publication, or adequate evidence of proof of publication, including an actual copy of the newspaper advertisement from a daily publication. For advertisements placed in a construction project clearinghouse such as www.construction.com, a screenshot of the advertisement, link to website, and receipt is required for proof of advertising.

- 2) List of all disadvantaged business enterprises (DBE) and non-DBE's that submitted proposals to the bidder/prime contractor. Specify as DBE or non-DBE, type of DBE, and the other information listed below (DBE Form #4 may be used for this purpose).

Name of Company
Name of Owners
Address of Company
E-mail Address of Company
Telephone Number
Date of Proposal
Type of Business
Type of DBE
Description of work to be performed

- 3) List of disadvantaged businesses that submitted proposals to the bidder but will not be utilized. Justification for non-utilization must be provided (may use IEPA DBE Form #1).
- 4) Completed and signed copies IEPA DBE Form #3 (Subcontractor Utilization Form) or equivalent "Notice of Intent". Only applies if using DBE subcontractors.
- 5) Completed and signed certification from bidder(s) attesting that the bidder has no dominating or conflict of interest with the disadvantaged business to be utilized (IEPA DBE Form #1). Only applies if using DBE subcontractors.
- 6) In instances where the bidder(s) does not receive any proposals from disadvantaged businesses prior to bid opening, the bidder(s) must provide a written certification attesting that no proposals were received (IEPA DBE Form #1).
- 7) **Note:** DBE Form #2 is **not** included in this packet. It is for consultants/engineers to report DBE activity. This form may be found in IEPA's DBE Guidance Manual which is available on the Agency's website or mailed upon request by calling 217-782-2027.

IEPA Disadvantaged Business Enterprise (DBE) Program Form #1
Contractor Certification Form

(To be completed by all Prime Contractors)

Please check the appropriate boxes that apply and complete the information on the bottom of the form.

- This firm will award no subcontracts (including in the procurement of equipment, supplies, or services), in the performance of this contract.
- This firm advertised for DBE subcontractors according to the good faith efforts outlined in the IEPA DBE Guidance Document.
- This firm received proposals from DBE(s) that will not be utilized. A list of the DBEs not hired, along with their address, phone number, and reason(s) for non-utilization, is below.

- This firm did not receive any inquiries from DBEs.

I certify that the above is true. I further certify that this firm and its partners, directors, and officers do not possess a controlling interest in ownership or conflict of interest or any other authority to control the DBE to be used during the performance of the contracts.

By: _____

NAME: _____

TITLE: _____

Company: _____

Date: ___/___/___

EPA Disadvantaged Business Enterprise (DBE) Program Form #3 Subcontractor Utilization Form

(Only complete this form if DBE subcontractors or sub-consultants will be working on a project)

This form is intended to capture the DBE subcontractor's description of work to be performed and the price of the work submitted to the prime contractor. All subcontractors must complete this form, and it must be included in the prime contractor's bid package.

Subcontractor Name	Project Name
Contact Person's Name & Title	
Address	
Telephone	Email
DBE Certified By:	Select all that apply. At least one is required: MBE WBE SBE DBE
Prime Contractor Name	
Type of Work to be Performed	Cost Estimate of Work

I certify under penalty of perjury that the forgoing statements are true and correct. Signing this form does not signify a commitment to using the subcontractors above. I am aware that in the event of a replacement of a subcontractor, I will adhere to the replacement requirements set forth in 40 C.F.R. Part 33 Section 33.302(c).

Prime Contractor Signature:	Print Name:
Date:	Title:
Subcontractor Signature:	Print Name:
Date:	Title:

IEPA Disadvantaged Business Enterprise (DBE) Program Form #4, Bidders List
(Only complete this form if subcontractors or sub-consultants will be working on a project)

Using this form/format is optional. Other formats are acceptable.

Company Name & Contact Person	Address	Phone No. w/ area code	Email	Proposed Work (supplies, paint, paint etc.)	DBE Status (MBE, WBE, DBE, SBE or Not Applicable)
					<p align="center">Check if Hired</p> <p align="center"><input type="checkbox"/></p>
					<p align="center">Check if Hired</p> <p align="center"><input type="checkbox"/></p>
					<p align="center">Check if Hired</p> <p align="center"><input type="checkbox"/></p>
					<p align="center">Check if Hired</p> <p align="center"><input type="checkbox"/></p>

**Bidder Certification Regarding the Use of
Iron, Steel, Manufactured Products, and Construction Materials produced in the United States
(Build America, Buy America Act)**

I _____, do hereby certify that:

Name

1. I am _____ (title) of the _____ (company, partnership, etc.) and have authority to execute this certification on behalf of the firm.
2. I am aware that all iron, steel, manufactured products, and construction materials used for this project must be produced in the United States per the federal Build America, Buy America Act (BABA) signed by President Biden on November 15, 2021. Pub. L No. 117-58, §§ 70901-52.
3. I understand the term “iron and steel products” refers to the following products made primarily of iron or steel: lined or unlined pipes and fittings manhole covers and other municipal castings, hydrants, tanks, flanges, pipe clamps and restraints, valves, structural steel, reinforced precast concrete, and construction materials.
4. I understand that all manufactured products used in the project must be produced in the United States. This means the manufactured product was manufactured in the United States, and the cost of the components of the manufactured product that are mined, produced, or manufactured in the United States is greater than 55 percent of the total cost of all components of the manufactured product.
5. I acknowledge that all construction materials for this project must be manufactured in the United States. This means all manufacturing processes for the construction materials occurred in the United States.
6. I am aware that this requirement applies to all portions of the project that are subcontracted.

Signature _____

Date _____

Corporate Seal (where appropriate)

Requirements Specific to Buy America, Build America Act (BABA)

On November 15, 2021, President Biden signed into law the Infrastructure Investment and Jobs Act (“IIJA”), Pub. L. No. 117-58, which includes the Build America, Buy America Act (“BABA”). The purpose of BABA is to ensure that federally funded infrastructure projects only utilize iron, steel, manufactured products, and construction materials produced in the United States. The requirement to use products produced in the United States applies to all projects for the construction, alteration, maintenance, or repair of publicly owned treatment works (POTW) or public water systems. Since Illinois’ Clean Water State Revolving Fund (CWSRF) and Drinking Water State Revolving Fund (DWSRF) utilize federal funds, loan recipients must use iron, steel, manufactured products, and construction materials that are produced in the United States. Guidance is available on USEPA’s website: <https://www.epa.gov/cwsrf/build-america-buy-america-baba>. Waivers from the requirements are available under certain circumstances. BABA requires the following:

1. All iron and steel used in the project are produced in the United States. This means all manufacturing processes, from the initial melting stage through the application of coatings, occurred in the United States.
2. All manufactured products used in the project are produced in the United States. This means the manufactured product was manufactured in the United States, and the cost of the components of the manufactured product that are mined, produced, or manufactured in the United States is greater than 55 percent of the total cost of all components of the manufactured product, unless another standard for determining the minimum amount of domestic content of the manufactured product has been established under applicable law or regulation.
3. All construction materials are manufactured in the United States. This means that all manufacturing processes for the construction material occurred in the United States.

BABA only applies to items that are consumed in, incorporated into, or affixed to an infrastructure project. It does not apply to tools, equipment, and supplies, such as temporary scaffolding, brought to the construction site and removed at project completion. BABA does not apply to equipment and furnishings, such as movable chairs, desks, and portable computer equipment, that are used at or within the finished infrastructure project but are not an integral part of or permanently affixed to the structure. BABA requirements apply to an entire infrastructure project, even if it is funded by both Federal and non-Federal funds under one or more awards.

Construction Materials includes an article, material, or supply that consists primarily of:

- non-ferrous metals;
- plastic and polymer-based products including polyvinylchloride, composite building materials, and polymers used in fiber optic cables;
- glass including optic glass;
- lumber; or
- drywall.

Construction Materials does NOT include items made primarily of iron or steel; manufactured products; cement and cementitious materials; aggregates such as stone, sand, or gravel; or aggregate binding agents or additives.

Requirements Specific to Iron and Steel

The existing American Iron and Steel (AIS) Requirements will continue as part of BABA. An iron or steel product is one of the items listed below and is made primarily of iron or steel that is permanently incorporated into the public water system or treatment works.

- Pipes (lined or unlined) and pipe fittings
- Pipe clamps and restraints
- Valves
- Structural steel
- Manhole Covers and other municipal castings such as valves boxes, drainage grates, bollards, etc.
- Construction materials such as trusses, wire, grating, wire, ductwork, fence tubing, wall panels, etc.
- Hydrants
- Flanges
- Tanks
- Reinforced precast concrete

For one of the listed iron or steel products to be considered subject to the BABA requirements, it must be made of greater than 50% iron or steel, measured by the material costs. “Steel” means an alloy that includes at least 50 percent iron, between .02 and 2 percent carbon, and may include other elements. Metallic elements such as chromium, nickel, molybdenum, manganese, and silicon may be added during the melting of steel for the purpose of enhancing properties such as corrosion resistance, hardness, or strength. The definition of steel covers carbon steel, alloy steel, stainless steel, tool steel and other specialty steels. AIS Guidance is available at: <https://epa.illinois.gov/topics/grants-loans/state-revolving-fund/guidance/american-iron-and-steel-requirements.html>.

Recordkeeping and Documenting the Country of Origin for Iron, Steel, Manufactured Products, & Construction Materials used in Loan Funded Projects

Loan recipients with assistance from their general contractor must be able to verify that products used in their projects comply with the BABA requirements. USEPA recommends loan recipients use a “Step Certification” process to ensure that producers adhere to the BABA requirements. Step certification is a process under which each handler (supplier, fabricator, manufacturer, etc.) of the iron, steel, manufactured products, or construction materials certifies that their step in the process was domestically performed. Each time a step in the manufacturing process takes place, the manufacturer delivers its work along with a certification of its origin.

A certification can be quite simple if it includes the name of the manufacturer, the location of the manufacturing facility (not company headquarters), a description of the product or item being delivered, and a signature by a manufacturer’s responsible party. Certification could be achieved by other methods such as requiring the final manufacturer, who delivers the products to the worksite, to provide certification that all manufacturing processes occurred in the US. While this type of certification is easier and acceptable, it may not provide the same degree of assurance and additional documentation

may be needed. USEPA auditors recommend keeping records of when and where the products were delivered. Records from the manufacturer should refer to specific items such as pipes, valves, meters. Try to avoid records containing broad statements such as, "All products delivered were USA made".

Regardless of the method, documents regarding the country of origin for all covered items should be collected and maintained by the loan recipients. Having a good paper trail is invaluable during an inspection or audit.

Sample Certification Letter

Below is a sample step certification letter for BABA compliance. The completed letter is provided to the construction contractor or loan applicant by the supplier, fabricator, manufacturer, etc. of covered products. Documentation must be provided on company letterhead.

Company Letterhead

Date

Company Name
Company Address
City, State, Zip

Subject: Build America, Buy America Act Step Certification for Project (Identify Project Here xxx)

I, (company representative), certify that the (melting, bending, coating, galvanizing, cutting, etc.) process for (manufacturing or fabricating) the following products and/or materials shipped or provided for the subject project are in full compliance with the federal Build America, Buy America Act requirements as required in EPA's State Revolving Fund Programs.

Item, Products, and/or Materials:

1. XXX
2. XXX
3. XXX

Such process took place at the following location (City and State must be included):

If any of the above compliance statements change while providing material for this project, we will immediately notify the prime contractor and the engineer.

Signed by Company Representative

Name Clearly Typed

Illinois Works Jobs Program Act – Apprenticeship Initiative
Information for Contractors

Summary: The Illinois Works Jobs Program Act, 30 ILCS 559/Art. 20, is a statewide initiative to ensure that all Illinois residents have access to State capital projects and careers in the construction industry and building trades and to provide contracting and employment opportunities to historically underrepresented populations in the construction industry. This will be accomplished through three programs created by the Illinois Works Jobs Program Act: the Illinois Works Apprenticeship Initiative, the Illinois Works Pre-Apprenticeship Program, and the Illinois Works Bid Credit Program. Additional information is available at the following website:

<https://www2.illinois.gov/dceo/WorkforceDevelopment/Pages/IllinoisWorksJobsProgramAct.aspx>.

The goal of the Illinois Works Apprenticeship Initiative (“10% apprenticeship goal”) is that for projects estimated to cost \$500,000 or more, apprentices will perform either 10% of the total labor hours actually worked in each prevailing wage classification or 10% of the estimated labor hours in each prevailing wage classification, whichever is less. The 10% apprenticeship goal applies to projects being paid for in whole or in part by appropriated capital funds to construct a public work either through a contract or grant issued by a State agency. A determination was made that this requirement also applies to IEPA loans. The \$500,000 threshold applies to the total project cost and NOT the total cost or value of an individual construction contract.

Certification: Apprentices are required to be U.S. Dept. of Labor certified (not limited to pre-apprentice program graduates).

Applicability

If a project is estimated to received \$500,000 or more of State Capital Funding for the Project:

If the state’s contribution to the project amount equals 50% or more of the cost for the project, the 10% apprenticeship requirement applies to all prevailing wage eligible work performed by contractors on the public works project.

If the state’s contribution to the project is less than 50% of the cost for the project, the 10% apprenticeship requirement applies only to prevailing wage eligible work being funded from state funds.

The Project has less than \$500,000 of State Capital Funding, but the Total Estimated Project Cost is \$500,000 or more:

If the state’s contribution to the project amount equals 50% or more of the estimated cost for the project, the 10% apprenticeship requirement applies to all prevailing wage eligible work performed by contractors on the public works project.

If the state’s contribution to the project is less than 50% of the estimated cost for the project, the 10% apprenticeship requirement does not apply.

Total Estimated Project Cost is less than \$500,000: The 10% apprenticeship requirement does not apply. The \$500,000 threshold applies to the total project cost and NOT the total cost or value of an individual construction contract.

Waivers from the Requirements: If goals cannot be met, the state has discretion to grant waivers, reductions or to hold public hearings on the issue. Factors to be considered include the scale of the project and whether the contractor or subcontractor seeking the action has previously requested reductions or waivers. A waiver form is available on the IEPA website at:

<https://epa.illinois.gov/content/dam/soi/en/web/epa/topics/grants-loans/state-revolving-fund/documents/WAIVER-REQUEST.pdf>. The form can also be obtained from DCEO.

Reporting: An example quarterly reporting form is attached. A fillable version is available on the IEPA website. Contractors should coordinate with the loan applicant and their consultant for further instructions regarding these forms. Loan applicants are ultimately responsible for reporting quarterly labor hours to the state, but coordination with their contractor is essential. All loan funded projects are subject to payment of Davis Bacon wages.

For general apprenticeship questions, please contact the Illinois Works Office at:
CEO.ILWorks@Illinois.gov.

Illinois Works Apprenticeship Initiative Periodic Grantee Report

Organization Name		FEIN Number		DUNS Number	
Grant Awarding Agency		Project Start Date		Project End Date	
Grant Number		Estimated Total Project Costs		Estimated Total State Contribution	

Reporting Period: Period Start Date Period End Date

Applicable Apprenticeship Goal (Select all that apply):

- 10% total project cost 10% total state contribution only
- Waiver Approved by IL DCEO IL DCEO Waiver Approval Date

(If a waiver was granted for any prevailing wage classification, the Grantee does not need to report on those classifications on this form.)

- Reduction Approved by IL DCEO IL DCEO Reduction Approval Date

(If selected, enter the applicable prevailing wage classification(s) and approved reduced percentage(s).)

Prevailing Wage Classification	Reduced Percentage	Prevailing Wage Classification	Reduced Percentage

Illinois Works Apprenticeship Initiative Periodic Grantee Report

Please provide information in this chart for the entire project if the apprenticeship goal applies to the entire project.
Provide information for only the state contribution if the apprenticeship goal applies only to state appropriated capital funds.

Prevailing Wage Classification	Total Hours for Classification in Reporting Period	Total Apprenticeship Hours for Classification in Reporting Period	% of Apprenticeship Hours	Total Hours for Classification (Cumulative from Start of the Project)	Total Apprenticeship Hours (Cumulative from Start of the Project)	% of Apprenticeship Hours (Cumulative from Start of the Project)	If no apprenticeship hours recorded, explain.

Organization Certification and State Agency Acknowledgement

1. Organization Certification:

By signing this form, I certify to the best of my knowledge and belief that the form is true, complete and accurate and that any false, fictitious or fraudulent information or the omission of any material fact could result in the immediate termination of my grant award(s).

Institution/Organization Name:

Printed Name (Executive Director or equivalent):

Signature (Executive Director or equivalent):

Title (Executive Director or equivalent):

Date/Time Field

2. State Agency Acknowledgement:

State Agency

Printed Name

Signature:

Title

Date/Time Field

GENERAL CONDITIONS

1. Definitions
2. Additional Instructions and Detail Drawings
3. Schedules, Reports and Records
- 4 Drawings and Specifications
5. Shop Drawings
6. Materials, Services and Facilities
7. Inspection and Testing
8. Substitutions
9. Patents
10. Surveys, Permits, Regulations
11. Protection of Work, Property, Persons
12. Supervision by Contractor
13. Changes in the Work
14. Changes in Contract Price
15. Time for Completion and Liquidated Damages
16. Correction of Work

17. Subsurface Conditions.
18. Suspension of Work, Termination and Delay
19. Payments to Contractor
20. Acceptance of Final Payment as Release
21. Insurance
22. Contract Security
23. Assignments
24. Indemnification
25. Separate Contracts
26. Subcontracting
27. Engineer's Authority
28. Land and Rights-of-Way
29. Guaranty
30. Arbitration
31. Taxes

DEFINITIONS

1.1 Wherever used in the CONTRACT DOCUMENTS, the following terms shall have the meanings indicated which shall be applicable to both the singular and plural thereof :

1.2 ADDENDA -Written or graphic instruments issued prior to the execution of the Agreement which modify or interpret the CONTRACT DOCUMENTS, DRAWINGS and SPECIFICATIONS, by additions, deletions, clarifications or corrections.

1.3 BID-The offer or proposal of the BIDDER submitted on the prescribed form setting forth the prices for the WORK to be performed.

1.4 BIDDER-Any person (s), firm or corporation submitting a BID for the WORK.

1.5 BONDS-Bid, Performance, and Payment Bonds and other instruments of security, furnished by the CONTRACTOR and his surety in accordance with the CONTRACT DOCUMENTS.

1.6 CHANGE ORDER-A written order to the CONTRACTOR authorizing an addition, deletion or revision in the WORK within the general scope of the CONTRACT DOCUMENTS, or authorizing an adjustment in the CONTRACT PRICE or CONTRACT TIME.

1.7 CONTRACT DOCUMENTS-The contract, including Advertisement For Bids, Information For Bidders, BID, Bid Bond, Agreement, Payment Bond, Performance Bond. NOTICE OF AWARD, NOTICE TO PROCEED, CHANGE ORDER, DRAWINGS, SPECIFICATIONS, and ADDENDA.

1.8 CONTRACT PRICE-The total monies payable to the CONTRACTOR under the terms and conditions of the CONTRACT DOCUMENTS.

1.9 CONTRACT TIME-The number of calendar days stated in the CONTRACT DOCUMENTS for the completion of the WORK.

1.10 CONTRACTOR-The person, firm or corporation with whom the OWNER has executed the Agreement.

1.11 DRAWINGS-The part of the CONTRACT DOCUMENTS which show the characteristics and scope of the WORK to be performed and which have been prepared or approved by the ENGINEER.

1.12 ENGINEER - The person, firm or corporation named as such in the CONTRACT DOCUMENTS.

1.13 FIELD ORDER - A written order effecting a change in the WORK not involving an adjustment in the CONTRACT PRICE or an extension of the CONTRACT TIME, issued by the ENGINEER to the CONTRACTOR during construction.

1.14 NOTICE OF AWARD - The written notice of the acceptance of the BID from the OWNER to the successful BIDDER.

1.15 NOTICE TO PROCEED - Written communication issued by the OWNER to the CONTRACTOR authorizing him to proceed with the WORK and establishing the date of commencement of the WORK.

1.16 OWNER - A public or quasi-public body or authority, corporation, association, partnership, or individual for whom the WORK is to be performed.

1.17 PROJECT-The undertaking to be performed as provided in the CONTRACT DOCUMENTS.

1.18 RESIDENT PROJECT REPRESENTATIVE-The authorized representative of the OWNER who is assigned to the PROJECT site or any part thereof.

1.19 SHOP DRAWINGS - All drawings, diagrams, illustrations, brochures, schedules and other data which are prepared by the CONTRACTOR, a SUBCONTRACTOR, manufacturer, SUPPLIER or distributor, which illustrate how specific portions of the WORK shall be fabricated or installed.

1.20 SPECIFICATIONS - A part of the CONTRACT DOCUMENTS consisting of written descriptions of a technical nature of materials, equipment, construction systems, standards and workmanship.

1.21 SUBCONTRACTOR-An individual, firm or corporation having a direct contract with the CONTRACTOR or with any other SUBCONTRACTOR for the performance of a part of the WORK at the site.

1.22 SUBSTANTIAL COMPLETION -That date as certified by the ENGINEER when the construction of the PROJECT or a specified part thereof is sufficiently completed, in accordance with the CONTRACT DOCUMENTS, so that the PROJECT or specified part can be utilized for the purposes for which it is intended.

1.23 SUPPLEMENTAL GENERAL CONDITIONS-

Modifications to General Conditions required by a Federal agency for participation in the PROJECT and approved by the agency in writing prior to inclusion in the CONTRACT DOCUMENTS, or such requirements that may be imposed by applicable state laws.

1.24 SUPPLIER -Any person or organization who supplies materials or equipment for the WORK, including that fabricated to a special design. but who does not perform labor at the site.

1.25 WORK -All labor necessary to produce the construction required by the CONTRACT DOCUMENTS, and all materials and equipment incorporated or to be incorporated in the PROJECT.

1.26 WRITTEN NOTICE -Any notice to any party of the Agreement relative to any part of this Agreement in writing and considered delivered and the service thereof completed, when posted by certified registered mail to the said party at his last given address, or delivered in person to said party or his authorized representative on the WORK. -

2. ADDITIONAL INSTRUCTIONS AND DETAIL DRAWINGS

2.1 The CONTRACTOR may be furnished additional instructions and detail drawings, by the ENGINEER, as necessary to carry out the WORK required by the CONTRACT DOCUMENTS.

2.2 The additional drawings and instruction thus supplied will become a part of the CONTRACT DOCUMENTS. The CONTRACTOR shall carry out the WORK in accordance with the additional detail drawings and instructions.

3. SCHEDULES, REPORTS AND RECORDS

3.1 The CONTRACTOR shall submit to the OWNER such schedule of quantities and costs, progress schedules, payrolls, reports, estimates, records and other data where applicable as are required by the CONTRACT DOCUMENTS for the WORK to be performed.

3.2 Prior to the first partial payment estimate the CONTRACTOR shall submit construction progress schedules showing the order in which he proposes to carry on the WORK, including dates at which he will start the various parts of the WORK. Estimated date of completion of each part and, as applicable:

3.2.1. The dates at which special detail drawings will be required; and

3.2.2 Respective dates for submission of SHOP DRAWINGS, the beginning of manufacture, the testing and the installation of materials, supplies and equipment.

3.3 The CONTRACTOR shall also submit a schedule of payments that he anticipates he will earn during the course of the WORK.

4. DRAWINGS AND SPECIFICATIONS

4.1 The intent of the DRAWINGS and SPECIFICATIONS is that the CONTRACTOR shall furnish all labor, materials, tools, equipment, and transportation necessary for the proper execution of the WORK in accordance with the CONTRACT DOCUMENTS and all incidental work necessary to complete the PROJECT in an acceptable manner, ready for use, occupancy or operation by the OWNER.

4.2 In case of conflict between the DRAWINGS and SPECIFICATIONS, the SPECIFICATIONS shall govern. Figure dimensions on DRAWINGS shall govern over scale dimensions, and detailed DRAWINGS shall govern over general DRAWINGS.

4.3 Any discrepancies found between the DRAWINGS and SPECIFICATIONS and site conditions or any inconsistencies or ambiguities in the DRAWINGS or SPECIFICATIONS shall be immediately reported to the ENGINEER, in writing, who shall promptly correct such inconsistencies or ambiguities in writing. WORK done by the CONTRACTOR after his discovery of such discrepancies, inconsistencies or ambiguities shall be done at the CONTRACTOR'S risk.

5. SHOP DRAWINGS

5.1 The CONTRACTOR shall provide SHOP DRAWINGS as may be necessary for the prosecution of the WORK as required by the CONTRACT DOCUMENTS. The ENGINEER shall promptly review all SHOP DRAWINGS. The ENGINEER'S approval of any SHOP DRAWING shall not release the CONTRACTOR from responsibility for deviations from the CONTRACT DOCUMENTS. The approval of any SHOP DRAWING which substantially deviates from the requirement of the CONTRACT DOCUMENTS shall be evidenced by a CHANGE ORDER.

5.2 When submitted for the ENGINEER'S review, SHOP DRAWINGS shall bear the CONTRACTOR'S certification that he has reviewed, checked and approved the SHOP DRAWINGS and that they are in conformance with the requirements of the CONTRACT DOCUMENTS.

5.3 Portions of the WORK requiring a SHOP DRAWING or sample submission shall not begin until the SHOP DRAWING or submission has been approved by the ENGINEER. A copy of each approved SHOP DRAWING and each approved sample shall be kept in good order by the CONTRACTOR at the site and shall be available to the ENGINEER.

6. MATERIALS, SERVICES AND FACILITIES

6.1 It is understood that, except as otherwise specifically stated in the CONTRACT DOCUMENTS, the CONTRACTOR shall provide and pay for all materials, labor, tools, equipment, water, light, power, transportation, supervision, temporary construction of any nature, and all other services and facilities of any nature whatsoever necessary to execute, complete, and deliver the WORK within the specified time.

6.2 Materials and equipment shall be so stored as to insure the preservation of their quality and fitness for the WORK. Stored materials and equipment to be incorporated in the WORK shall be located so as to facilitate prompt inspection.

6.3 Manufactured articles, materials and equipment shall be applied, installed, connected, erected, used, cleaned and conditioned as directed by the manufacturer.

6.4 Materials, supplies and equipment shall be in accordance with samples submitted by the CONTRACTOR and approved by the ENGINEER.

6.5 Materials, supplies or equipment to be incorporated into the WORK shall not be purchased by the CONTRACTOR

or the SUBCONTRACTOR subject to a chattel mortgage or under a conditional sale contract or other agreement by which an interest is retained by the seller.

7. INSPECTION AND TESTING

7.1 All materials and equipment used in the construction of the PROJECT shall be subject to adequate inspection and testing in accordance with generally accepted standards, as required and defined in the CONTRACT DOCUMENTS.

7.2 The OWNER shall provide all inspection and testing services not required by the CONTRACT DOCUMENTS.

7.3 The CONTRACTOR shall provide at his expense the testing and inspection services required by the CONTRACT DOCUMENTS.

7.4 If the CONTRACT DOCUMENTS, laws, ordinances, rules, regulations or orders of any public authority having jurisdiction require any WORK to specifically be inspected, tested, or approved by someone other than the CONTRACTOR, the CONTRACTOR will give the ENGINEER timely notice of readiness. The CONTRACTOR will then furnish the ENGINEER the required certificates of inspection, testing or approval.

7.5 Inspections, tests or approvals by the engineer or others shall not relieve the CONTRACTOR from his obligations to perform the WORK in accordance with the requirements of the CONTRACT DOCUMENTS.

7.6 The ENGINEER and his representatives will at all times have access to the WORK. In addition, authorized representatives and agents of any participating Federal or state agency shall be permitted to inspect all work, materials, payrolls, records of personnel, invoices of materials, and other relevant data and records. The CONTRACTOR will provide proper facilities for such access and observation of the WORK and also for any inspection, or testing thereof.

7.7 If any WORK is covered contrary to the written instructions of the ENGINEER it must, if requested by the ENGINEER, be uncovered for his observation and replaced at the CONTRACTOR'S expense.

7.8 If the ENGINEER considers it necessary or advisable that covered WORK be inspected or tested by others, the CONTRACTOR, at the ENGINEER'S request, will uncover, expose or otherwise make available for observation, inspection or testing as the engineer may require, that portion of the WORK in question, furnishing all necessary labor, materials, tools, and equipment. If it is found that such WORK is defective, the CONTRACTOR will bear all the expenses of such uncovering, exposure, observation, inspection and testing and of satisfactory reconstruction. If, however, such WORK is not found to be defective, the CONTRACTOR will be allowed an increase in the CONTRACT PRICE or an extension of the CONTRACT TIME, or both, directly attributable to such uncovering, exposure, observation, inspection, testing and reconstruction and an appropriate CHANGE ORDER shall be issued.

8. SUBSTITUTIONS

8.1 Whenever a material, article or piece of equipment

is identified on the DRAWINGS or SPECIFICATIONS by reference to brand name or catalogue number, it shall be understood that this is referenced for the purpose of defining the performance or other salient requirements and that other products of equal capacities, quality and function shall be considered. The CONTRACTOR may recommend the substitution of a material, article, or piece of equipment of equal substance and function for those referred to in the CONTRACT DOCUMENTS by reference to brand name or catalogue number, and if, in the opinion of the ENGINEER, such material, article, or piece of equipment is of equal substance and function to that specified. The ENGINEER may approve its substitution and use by the CONTRACTOR. Any cost differential shall be deductible from the CONTRACT PRICE and the CONTRACT DOCUMENTS shall be appropriately modified by CHANGE ORDER. The CONTRACTOR warrants that if substitutes are approved, no major changes in the function or general design of the PROJECT will result. Incidental changes or extra component parts required to accommodate the substitute will be made by the CONTRACTOR without a change in the CONTRACT PRICE or CONTRACT TIME.

9. PATENTS

9.1 The CONTRACTOR shall pay all applicable royalties and license fees. He shall defend all suits or claims for infringement of any patent rights and save the OWNER harmless from loss on account thereof, except that the OWNER shall be responsible for any such loss when a particular process, design, or the product of a particular manufacturer or manufacturers is specified, however if the CONTRACTOR has reason to believe that the design, process or product specified is an infringement of a patent, he shall be responsible for such loss unless he promptly gives such information to the ENGINEER.

10. SURVEYS, PERMITS, REGULATIONS

10.1 The OWNER shall furnish all boundary surveys and establish all base lines for locating the principal component parts of the WORK together with a suitable number of bench marks adjacent to the WORK as shown in the CONTRACT DOCUMENTS. From the information provided by the OWNER, unless otherwise specified in the CONTRACT DOCUMENTS, the CONTRACTOR shall develop and make all detail surveys needed for construction such as slope stakes, batter boards, stakes for pile locations, and other working points, lines, elevations and cut sheets.

10.2 The CONTRACTOR shall carefully preserve bench marks, reference points and stakes and, in case of willful or careless destruction, he shall be charged with the resulting expense and shall be responsible for any mistakes that may be caused by their unnecessary loss or disturbance.

10.3 Permits and licenses of a temporary nature necessary for the prosecution of the WORK shall be secured and paid for by the CONTRACTOR unless otherwise stated in the SUPPLEMENTAL GENERAL CONDITIONS. Permits, licenses and easements for permanent structures or permanent changes in existing facilities shall be secured and paid for by the OWNER, unless otherwise specified. The CONTRACTOR shall give all notices and comply with all laws, ordinances, rules and regulations bearing on the conduct of the WORK as drawn and specified. If the CONTRACTOR observes that the CONTRACT DOCUMENTS

are at variance therewith, he shall promptly notify the ENGINEER in writing, and any necessary changes shall be adjusted as provided in Section 13, CHANGES IN THE WORK.

11. PROTECTION OF WORK, PROPERTY AND PERSONS

11.1 The CONTRACTOR will be responsible for initiating, maintaining and supervising all safety precautions and programs in connection with the WORK. He will take all necessary precautions for the safety of, and will provide the necessary protection to prevent damage, injury or loss to all employees on the WORK and other persons who may be affected thereby, all the WORK and all materials or equipment to be incorporated therein, whether in storage on or off the site, and other property at the site or adjacent thereto, including trees, shrubs, lawns, walks, pavements, roadways, structures and utilities not designated for removal, relocation or replacement in the course of construction.

11.2 The CONTRACTOR will comply with all applicable laws, ordinances, rules, regulations and orders of any public body having jurisdiction. He will erect and maintain, as required by the conditions and progress of the WORK, all necessary safeguards for safety and protection. He will notify owners of adjacent utilities when prosecution of the WORK may affect them. The CONTRACTOR will remedy all damage, injury or loss to any property caused, directly or indirectly, in whole or in part, by the CONTRACTOR, any SUBCONTRACTOR or anyone directly or indirectly employed by any of them or anyone for whose acts any of them be liable, except damage or loss attributable to the fault of the CONTRACTOR DOCUMENTS or to the acts or omissions of the OWNER or the ENGINEER or anyone employed by either of them or anyone for whose acts either of them may be liable, and not attributable, directly or indirectly, in whole or in part, to the fault or negligence of the CONTRACTOR.

11.3 In emergencies affecting the safety of persons or the WORK or property at the site or adjacent thereto, the CONTRACTOR, without special instruction or authorization from the ENGINEER or OWNER, shall act to prevent threatened damage, injury or loss. He will give the ENGINEER prompt WRITTEN NOTICE of any significant changes in the WORK or deviations from the CONTRACT DOCUMENTS caused thereby, and a CHANGE ORDER shall thereupon be issued covering the changes and deviations involved.

12. SUPERVISION BY CONTRACTOR

12.1 The CONTRACTOR will supervise and direct the WORK. He will be solely responsible for the means, methods, techniques, sequences and procedures of construction. The CONTRACTOR will employ and maintain on the WORK a qualified supervisor or superintendent who shall have been designated in writing by the CONTRACTOR as the CONTRACTOR'S representative at the site. The supervisor shall have full authority to act on behalf of the CONTRACTOR and all communications given to the supervisor shall be as binding as if given to the CONTRACTOR. The supervisor shall be present on the site at all times as required to perform adequate supervision and coordination of the WORK.

13. CHANGES IN THE WORK

13.1 The OWNER may at any time, as the need arises,

order changes within the scope of the WORK without invalidating the Agreement. If such changes increase or decrease the amount due under the CONTRACT DOCUMENTS, or in the time required for performance of the WORK, an equitable adjustment shall be authorized by CHANGE ORDER.

13.2 The ENGINEER, also, may at any time, by issuing a FIELD ORDER, make changes in the details of the WORK. The CONTRACTOR shall proceed with the performance of any changes in the WORK so ordered by the ENGINEER unless the CONTRACTOR believes that such FIELD ORDER entitles him to a change in CONTRACT PRICE or TIME, or both. In which event he shall give the ENGINEER WRITTEN NOTICE thereof within seven (7) days after the receipt of the ordered change. Thereafter the CONTRACTOR shall document the basis for the change in CONTRACT PRICE or TIME within thirty (30) days. The CONTRACTOR shall not execute such changes pending the receipt of an executed CHANGE ORDER or further instruction from the OWNER.

14. CHANGES IN CONTRACT PRICE

14.1 The CONTRACT PRICE may be changed only by a CHANGE ORDER. The Value of any WORK covered by a CHANGE ORDER or of any claim for increase or decrease in the CONTRACT PRICE shall be determined by one or more of the following methods in the order of precedence listed below:

- (a) Unit prices previously approved.
- (b) An agreed lump sum.
- (c) The actual cost for labor, direct overhead, materials, supplies, equipment, and other services necessary to complete the work. In addition there shall be added an amount to be agreed upon but not to exceed fifteen (15) percent of the actual cost of the WORK to cover the cost of general overhead and profit.

15. TIME FOR COMPLETION AND LIQUIDATED DAMAGES

15.1 The date of beginning and the time for completion of the WORK are essential conditions of the CONTRACT DOCUMENTS and the WORK embraced shall be commenced on a date specified in the NOTICE TO PROCEED.

15.2 The CONTRACTOR will proceed with the WORK at such rate of progress to insure full completion within the CONTRACT TIME. It is expressly understood and agreed, by and between the CONTRACTOR and the OWNER, that the CONTRACT TIME for the completion of the WORK described herein is a reasonable time, taking into consideration the average climatic and economic conditions and other factors prevailing in the locality of the WORK.

15.3 If the CONTRACTOR shall fail to complete the WORK within the CONTRACT TIME, or extension of time granted by the OWNER, then the CONTRACTOR will pay to the OWNER the amount for liquidated damages as specified in the BID for each calendar day that the CONTRACTOR shall be in default after the time stipulated in the CONTRACT DOCUMENTS.

15.4 The CONTRACTOR shall not be charged with liquidated damages or any excess cost when the delay in completion of the WORK is due to the following, and the CONTRACTOR has promptly given WRITTEN NOTICE of such delay to the OWNER or ENGINEER.

15.4.1 To any preference, priority or allocation duly issued by the OWNER

15.4.2 To unforeseeable causes beyond the control and without the fault or negligence of the CONTRACTOR, including but not restricted to, acts of God, or of the public enemy, acts of the OWNER, acts of another CONTRACTOR in the performance of a contract with the OWNER, fires, floods, epidemics, quarantine restrictions, strikes, freight embargoes, and abnormal and unforeseeable weather; and

15.4.3 To any delays of SUBCONTRACTORS occasioned by any of the causes specified in paragraphs 15.4.1 and 15.4.2 of this article.

16. CORRECTION OF WORK

16.1 The CONTRACTOR shall promptly remove from the premises all WORK rejected by the ENGINEER for failure to comply with the CONTRACT DOCUMENTS, whether incorporated in the construction or not, and the CONTRACTOR shall promptly replace and re-execute the WORK in accordance with the CONTRACT DOCUMENTS and without expense to the OWNER and shall bear the expense of making good all WORK of other CONTRACTORS destroyed or damaged by such removal or replacement.

16.2 All removal and replacement WORK shall be done at the CONTRACTOR'S expense. If the CONTRACTOR does not take action to remove such rejected WORK within ten (10) days after receipt of WRITTEN NOTICE, the OWNER may remove such WORK and store the materials at the expense of the CONTRACTOR.

17. SUBSURFACE CONDITIONS

17.1 The CONTRACTOR shall promptly, and before such conditions are disturbed, except in the event of an emergency, notify the OWNER by WRITTEN NOTICE of:

17.1.1 Subsurface or latent physical conditions at the site differing materially from those indicated in the CONTRACT DOCUMENTS; or

17.1.2 Unknown physical conditions at the site, of an unusual nature, differing materially from those ordinarily encountered and generally recognized as inherent in WORK of the character provided for in the CONTRACT DOCUMENTS.

17.2 The OWNER shall promptly investigate the conditions, and if he finds that such conditions do so materially differ and cause an increase or decrease in the cost of, or in the time required for, performance of the WORK, an equitable adjustment shall be made and the CONTRACT DOCUMENTS shall be modified by a CHANGE ORDER. Any claim of the CONTRACTOR for adjustment hereunder shall not be allowed unless he has given the required WRITTEN NOTICE; provided that the OWNER may, if he determines the facts so justify, consider and adjust any such claims asserted before the date of final payment.

18. SUSPENSION OF WORK, TERMINATION AND DELAY

18.1 The OWNER may suspend the WORK or any portion thereof for a period of not more than ninety days or such further time as agreed upon by the CONTRACTOR, by WRITTEN NOTICE to the CONTRACTOR and the ENGINEER which notice shall fix the date on which WORK shall be resumed. The CONTRACTOR

will resume that WORK on the date so fixed. The CONTRACTOR will be allowed an increase in the CONTRACT PRICE or an extension of the CONTRACT TIME, or both, directly attributable to any suspension.

18.2 If the CONTRACTOR is adjudged a bankrupt or insolvent, or if he makes a general assignment for the benefit of his creditors, or if a trustee or receiver is appointed for the CONTRACTOR or for any of his property, or if he files a petition to take advantage of any debtor's act, or to reorganize under the bankruptcy or applicable laws, or if he repeatedly fails to supply sufficient skilled workmen or suitable materials or equipment, or if he repeatedly fails to make prompt payments to SUBCONTRACTORS or for labor, materials or equipment or if he disregards laws, ordinances, rules, regulations or orders of any public body having jurisdiction of the WORK or if he disregards the authority of the ENGINEER, or if he otherwise violates any provision of the CONTRACT DOCUMENTS, then the OWNER may, without prejudice to any other right or remedy and after giving the CONTRACTOR and his surety a minimum of ten (10) days from delivery of a WRITTEN NOTICE, terminate the services of the CONTRACTOR and take possession of the PROJECT and of all materials, equipment, tools, construction equipment and machinery thereon owned by the CONTRACTOR, and finish the WORK by whatever method he may deem expedient. In such case the CONTRACTOR shall not be entitled to receive any further payment until the WORK is finished. If the unpaid balance of the CONTRACT PRICE exceeds the direct and indirect costs of completing the PROJECT, including compensation for additional professional services, such excess SHALL BE PAID TO THE CONTRACTOR. If such costs exceed such unpaid balance, the CONTRACTOR will pay the difference to the OWNER. Such costs incurred by the OWNER will be determined by the ENGINEER and incorporated in a CHANGE ORDER.

18.3 Where the CONTRACTOR'S services have been so terminated by the OWNER, said termination shall not affect any right of the OWNER against the CONTRACTOR then existing or which may thereafter accrue. Any retention or payment of monies by the OWNER due the CONTRACTOR will not release the CONTRACTOR from compliance with the CONTRACT DOCUMENTS.

18.4 After ten (10) days from delivery of a written NOTICE to the CONTRACTOR and the ENGINEER, the OWNER may, without cause and without prejudice to any other right or remedy, elect to abandon the PROJECT and terminate the Contract. In such case, the CONTRACTOR shall be paid for all WORK executed and any expense sustained plus reasonable profit.

18.5 If, through no act or fault of the CONTRACTOR, the WORK is suspended for a period of more than ninety (90) days by the OWNER or under an order of court or other public authority, or the ENGINEER fails to act on any request for payment within thirty (30) days after it is submitted, or the OWNER fails to pay the CONTRACTOR substantially the sum approved by the ENGINEER or awarded by arbitrators within thirty (30) days of its approval and presentation, then the CONTRACTOR may, after ten (10) days from delivery of a WRITTEN NOTICE to the OWNER and the ENGINEER, terminate the CONTRACT and recover from the OWNER payment for all WORK executed

and all expenses sustained. In addition and in lieu of terminating the CONTRACT, if the ENGINEER has failed to act on a request for payment or if the OWNER has failed to make any payment as aforesaid, the CONTRACTOR may upon ten (10) days written notice to the OWNER and the ENGINEER stop the WORK until he has been paid all amounts then due, in which event and upon resumption of the WORK, CHANGE ORDERS shall be issued for adjusting the CONTRACT PRICE or extending the CONTRACT TIME or both to compensate for the costs and delays attributable to the stoppage of the WORK.

18.6 If the performance of all or any portion of the WORK is suspended, delayed, or interrupted as a result of a failure of the OWNER or ENGINEER to act within the time specified in the CONTRACT DOCUMENTS, or if no time is specified, within a reasonable time, an adjustment in the CONTRACT price or an extension of the CONTRACT TIME, or both, shall be made by CHANGE ORDER to compensate the CONTRACTOR for the costs and delays necessarily refused by the failure of the OWNER or ENGINEER.

19. PAYMENTS TO CONTRACTOR

19.1 At least ten (10) days before each progress payment falls due (but not more often than once a month), the CONTRACTOR will submit to the ENGINEER a partial payment estimate filled out and signed by the CONTRACTOR covering the WORK performed during the period covered by the partial payment estimate and supported by such data as the ENGINEER may reasonably require. If payment is requested on the basis of materials and equipment not incorporated in the WORK but delivered and suitably stored at or near the site, the partial payment estimate shall also be accompanied by such supporting data, satisfactory to the OWNER, as will establish the OWNER'S title to the material and equipment and protect his interest therein, including applicable insurance. The ENGINEER will, within ten (10) days after receipt of each partial payment estimate, either indicate in writing his approval of payment and present the partial payment estimate to the OWNER, or return the partial payment estimate to the CONTRACTOR indicating in writing his reasons for refusing to approve payment. In the latter case, the CONTRACTOR may make the necessary corrections and resubmit the partial payment estimate. The OWNER will, within ten (10) days of presentation to him of an approved partial payment estimate, pay the CONTRACTOR a progress payment on the basis of the approved partial payment estimate. The OWNER shall retain ten (10) percent of the amount of each payment until final completion and acceptance of all work covered by the CONTRACT DOCUMENTS. The OWNER at any time, however, after fifty (50) percent of the WORK has been completed, if he finds that satisfactory progress is being made, shall reduce retainage to five (5%) percent on the current and remaining estimates. When the WORK is substantially complete (operational or beneficial occupancy), the retained amount may be further reduced below five (5) percent to only that amount necessary to assure completion. On completion and acceptance of a part of the WORK on which the price is stated separately in the CONTRACT DOCUMENTS, payment may be made in full, including retained percentages, less authorized deductions.

19.2 The request for payment may also include an allowance for the cost of such major materials and equipment which are

suitably stored either at or near the site.

19.3 Prior to SUBSTANTIAL COMPLETION, the OWNER, with the approval of the ENGINEER and with the concurrence of the CONTRACTOR, may use any completed or substantially completed portions of the WORK. Such use shall not constitute an acceptance of such portions of the WORK.

19.4 The OWNER shall have the right to enter the premises for the purpose of doing work not covered by the CONTRACT DOCUMENTS. This provision shall not be construed as relieving the CONTRACTOR of the sole responsibility for the care and protection of the WORK, or the restoration of any damaged WORK except such as may be caused by agents or employees of the OWNER.

19.5 Upon completion and acceptance of the WORK, the ENGINEER shall issue a certificate attached to the final payment request that the WORK has been accepted by him under the conditions of the CONTRACT DOCUMENTS. The entire balance found to be due the CONTRACTOR, including the retained percentages, but except such sums as may be lawfully retained by the OWNER, shall be paid to the CONTRACTOR within thirty (30) days of completion and acceptance of the WORK.

19.6 The CONTRACTOR will indemnify and save the OWNER or the OWNER'S agents harmless from all claims growing out of the lawful demands of SUBCONTRACTORS, laborers, workmen, mechanics, materialmen, and furnishers of machinery and parts thereof, equipment, tools, and all supplies, incurred in the furtherance of the performance of the WORK. The CONTRACTOR shall, at the OWNER'S request, furnish satisfactory evidence that all obligations of the nature designated above have been paid, discharged, or waived. If the CONTRACTOR fails to do so the OWNER may, after having notified the CONTRACTOR, either pay unpaid bills or withhold from the CONTRACTOR'S unpaid compensation a sum of money deemed reasonably sufficient to pay any and all such lawful claims until satisfactory evidence is furnished that all liabilities have been fully discharged where- upon payment to the CONTRACTOR shall be resumed, in accordance with the terms of the CONTRACT documents but in no event shall the provisions of this sentence be construed to impose any obligations upon the OWNER to either the CONTRACTOR, his Surety, or any third party. In paying any unpaid bills of the CONTRACTOR, any payment so made by the OWNER shall be considered as a payment made under the CONTRACT DOCUMENTS by the OWNER to the CONTRACTOR and the OWNER shall not be liable to the CONTRACTOR for any such payments made in good faith.

19.7 If the OWNER fails to make payment thirty (30) days after approval by the ENGINEER, in addition to other remedies available to the CONTRACTOR, there shall be added to each such payment interest at the maximum legal rate commencing on the first day after said payment is due and continuing until the payment is received by the CONTRACTOR.

20. ACCEPTANCE OF FINAL PAYMENT AS RELEASE

20.1 The acceptance by the CONTRACTOR of final payment shall be and shall operate as a release to the OWNER of all claims and all liability to the CONTRACTOR other than claims in stated amounts as may be specifically excepted by the CONTRACTOR for all things done or furnished in connection with this WORK and for every act and neglect of the OWNER and others relating to or arising out of this WORK. Any payment, however, final or otherwise, shall not release the CONTRACTOR or his sureties from any obligations under the CONTRACT DOCUMENTS or the Performance BOND and Payment BONDS.

21. INSURANCE

21.1 The CONTRACTOR shall purchase and maintain such insurance as will protect him from claims set forth below which may arise out of or result from the CONTRACTOR'S execution of the WORK, whether such execution be by himself or by any SUBCONTRACTOR or by anyone directly or indirectly employed by any of them, or by anyone for whose acts any of them may be liable:

21.1.1 Claims under workmen's compensation, Disability benefit and other similar employee benefit acts;

21.1.2 Claims for damages because of bodily injury, occupational sickness or disease, or death of his employees:

21.1.3 Claims for damages because of bodily injury, sickness or disease, or death of any person other than his employees:

21.1.4 Claims for damages insured by usual personal injury liability coverage which are sustained (1) by any person as a result of an offense directly or indirectly related to the employment of such person by the CONTRACTOR, or (2) by any other person; and

21.1.5 Claims for damages because of injury to or destruction of tangible property, including loss of use resulting there from.

21.2 Certificates of Insurance acceptable to the OWNER shall be filed with the OWNER prior to commencement of the WORK. These Certificates shall contain a provision that coverages afforded under the policies will not be cancelled unless at least fifteen (15) days prior WRITTEN NOTICE has been given to the OWNER. The Owner, Engineer, & IEPA shall be named additional insureds with regard to General and Automotive Liability

21.3 The CONTRACTOR shall procure and maintain, at his own expense, during the CONTRACT TIME, liability insurance as hereinafter specified:

21.3.1 CONTRACTOR'S General Public Liability and Property Damage Insurance including vehicle coverage issued to the CONTRACTOR and protecting him from all claims for personal injury, including death, and all claims for destruction of or damage to property arising out of or in connection with any

operations under the CONTRACT DOCUMENTS, whether such operations be by himself or by any SUBCONTRACTOR under him, or anyone directly or indirectly employed by the CONTRACTOR or by a SUBCONTRACTOR under him. Insurance shall be written with a limit of liability of not less than \$500,000 for all damages arising out of bodily injury, including death, at any time resulting there from, sustained by any one person in any one accident; and a limit of liability of not less than \$500,000 aggregate for any such damages sustained by two or more persons in any one accident. Insurance shall be written with a limit of liability of not less than \$200,000 for all property damage sustained by any one person in any one accident; and a limit of liability of not less than \$200,000 aggregate for any such damage sustained by two or more persons in any one accident.

21.3.2 The CONTRACTOR shall acquire and maintain, if applicable, Fire and Extended Coverage insurance upon the PROJECT to the full insurable value thereof for the benefit of the OWNER, the CONTRACTOR, and SUBCONTRACTORS as their interest may appear. This provision shall in no way release the CONTRACTOR or CONTRACTOR'S surety from obligations under the CONTRACT DOCUMENTS to fully complete the PROJECT.

21.4 The CONTRACTOR shall procure and maintain, at his own expense, during the CONTRACT TIME, In accordance with the provisions of the laws of the state in which the work is performed, Workmen's Compensation Insurance, including occupational disease provisions, for all of his employees at the site of the PROJECT and in case any work is sublet, the CONTRACTOR shall require such SUBCONTRACTOR similarly to provide Workmen's Compensation Insurance, including occupational disease provisions for all of the latter's employees unless such employees are covered by the protection afforded by the CONTRACTOR. In case any class of employees engaged in hazardous work under this contract at the site of the PROJECT is not projected under Workmen's Compensation statute, the CONTRACTOR shall provide, and shall cause each SUBCONTRACTOR to provide, adequate and suitable insurance for the protection of his employees not otherwise protected.

21.5 The CONTRACTOR shall secure, if applicable, "All Risk" type Builder's Risk Insurance for WORK to be performed. Unless specifically authorized by the OWNER, the amount of such insurance shall not be less than the CONTRACT PRICE totaled in the BID. The policy shall cover not less than the losses due to fire, explosion, hail, lightning, vandalism, malicious mischief, wind, collapse, riot, aircraft, and smoke during the CONTRACT TIME, and until the WORK is accepted by the OWNER. The policy shall name as the insured the CONTRACTOR, the ENGINEER, and the OWNER.

22. CONTRACT SECURITY

22.1 The CONTRACTOR shall within ten (10) days after the receipt of the NOTICE OF AWARD furnish the OWNER with a Performance Bond and a Payment Bond in penal sums equal to the amount of the CONTRACT PRICE, conditioned upon the performance by the CONTRACTOR of all undertakings,

covenants, terms, conditions and agreements of the CONTRACT DOCUMENTS, and upon the prompt payment by the CONTRACTOR to all persons supplying labor and materials in the prosecution of the WORK provided by the CONTRACT DOCUMENTS. Such BONDS shall be executed by the CONTRACTOR and a corporate bonding company licensed to transact such business in the state in which the WORK is to be performed and named on the current list of "Surety Companies Acceptable on Federal Bonds" as published in the Treasury Department Circular Number 570. The expense of these BONDS shall be borne by the CONTRACTOR. If at any time a surety on any such BOND is declared a bankrupt or loses its right to do business in the state in which the WORK is to be performed or is removed from the list of Surety Companies accepted on Federal BONDS, CONTRACTOR shall within ten (10) days after notice from the OWNER to do so, substitute an acceptable BOND (or BONDS) in such form and sum and signed by such other surety or sureties as may be satisfactory to the OWNER. The premiums on such BOND shall be paid by the CONTRACTOR. No further payments shall be deemed due nor shall be made until the new surety or sureties shall have furnished an acceptable BOND to the OWNER.

23. ASSIGNMENTS

23.1 Neither the CONTRACTOR nor the OWNER shall sell, transfer, assign or otherwise dispose of the Contract or any portion thereof, or of his right, title or interest therein, or his obligations there under, without written consent of the other party.

24. INDEMNIFICATION

24.1 The CONTRACTOR will indemnify, and hold harmless the OWNER and the ENGINEER and their agents and employees from and against all claims, damages, losses and expenses including attorney's fees arising out of or resulting from the performance of the WORK, provided that any such claims, damage, loss or expense is attributable to bodily injury, sickness, disease or death, or to injury to or destruction of tangible property including the loss of use resulting there from; and is caused in whole or in part by any negligent or willful act or omission of the CONTRACTOR, and SUBCONTRACTOR, anyone directly or indirectly employed by any of them or anyone for whose acts any of them may be liable.

24.2 In any and all claims against the OWNER or the ENGINEER, or any of their agents or employees, by any employee of the CONTRACTOR, any SUBCONTRACTOR, anyone directly or indirectly employed by any of them, or anyone for whose acts any of them may be liable, the indemnification obligation shall not be limited in any way by any limitation on the amount or type of damages, compensation or benefits payable by or for the CONTRACTOR or any SUBCONTRACTOR under workmen's compensation acts, disability benefit acts or other employee benefits acts.

24.3 The obligation of the CONTRACTOR under this paragraph shall not extend to the liability of the ENGINEER, his agents or employees arising out of the preparation or approval of maps, DRAWINGS, opinions, reports, surveys, CHANGE ORDERS, designs or SPECIFICATIONS.

25. SEPARATE CONTRACTS

25.1 The OWNER reserves the right to let other contracts

in connection with this PROJECT. The CONTRACTOR shall afford other CONTRACTORS reasonable opportunity for the introduction and storage of their materials and the execution of their WORK, and shall properly connect and coordinate his WORK with theirs. If the proper execution or results of any part of the CONTRACTOR'S WORK depends upon the WORK of any other CONTRACTOR, the CONTRACTOR shall inspect and promptly report to the ENGINEER any defects in such WORK that render it unsuitable for such proper execution and results.

25.2 The OWNER may perform additional WORK related to the PROJECT by himself, or he may let other contracts containing provisions similar to these. The CONTRACTOR will afford the other CONTRACTORS who are parties to such Contracts (or the OWNER, if he is performing the additional WORK himself), reasonable opportunity for the introduction and storage of materials and equipment and the execution of WORK, and shall properly connect and coordinate his WORK with theirs.

25.3 If the performance of additional WORK by other CONTRACTORS or the OWNER is not noted in the CONTRACT DOCUMENTS prior to the execution of the CONTRACT, written notice thereof shall be given to the CONTRACTOR prior to starting any such additional WORK. If the CONTRACTOR believes that the performance of such additional WORK by the OWNER or Others involves him in additional expense or entitles him to an extension of the CONTRACT TIME, he may make a claim therefore as provided in Sections 14 and 15.

26. SUBCONTRACTING

26.1 The CONTRACTOR may utilize the services of specialty SUBCONTRACTORS on those parts of the WORK which, under normal contracting practices, are performed by specialty SUBCONTRACTORS.

26.2 The CONTRACTOR shall not award WORK to SUBCONTRACTOR(s), in excess of fifty (50%) percent of the CONTRACT PRICE without prior written approval of the OWNER.

26.3 The CONTRACTOR shall be fully responsible to the OWNER for the acts and omissions of his SUBCONTRACTORS, and of persons either directly or indirectly employed by them, as he is for the acts and omissions of persons directly employed by him.

26.4 The CONTRACTOR shall cause appropriate provisions to be inserted in all subcontracts relative to the WORK to bind SUBCONTRACTORS to the CONTRACTOR by the terms of the CONTRACT DOCUMENTS insofar as applicable to the WORK of SUBCONTRACTORS and to give the CONTRACTOR the same power as regards terminating any subcontract that the OWNER may exercise over the CONTRACTOR tender any provision of the CONTRACT DOCUMENTS.

26.5 Nothing contained in this CONTRACT shall create any contractual relation between any SUBCONTRACTOR and the OWNER.

27. ENGINEER'S AUTHORITY

27.1 The ENGINEER shall act as the OWNER'S representative during the construction period. He shall decide questions which may arise as to quality and acceptability of materials furnished and WORK performed. He shall interpret the intent of the CONTRACT DOCUMENTS in a fair and unbiased manner. The

ENGINEER will make visits to the site and determine if the WORK is proceeding in accordance with the CONTRACT DOCUMENTS.

27.2 The CONTRACTOR will be held strictly to the intent of the CONTRACT DOCUMENTS in regard to the quality of materials, workmanship and execution of the WORK. Inspections may be made at the factory or fabrication plant of the source of material supply.

27.3 The ENGINEER will not be responsible for the construction means, controls, techniques, sequences, procedures, or construction safety.

27.4 The ENGINEER shall promptly make decisions relative to interpretation of the CONTRACT DOCUMENTS.

28. LAND AND RIGHTS-OF-WAY

28.1 Prior to issuance of NOTICE TO PROCEED, the OWNER shall obtain all land and rights-of-way necessary for carrying out and for the completion of the WORK to be performed pursuant to the CONTRACT DOCUMENTS, unless otherwise mutually agreed.

28.2 The OWNER shall provide to the CONTRACTOR information which delineates and describes the lands owned and rights-of-way acquired.

28.3 The CONTRACTOR shall provide at his own expense and without liability to the OWNER any additional land and access thereto that the CONTRACTOR may desire for temporary construction facilities, or for storage of materials.

29. GUARANTY

29.1 The CONTRACTOR shall guarantee all materials and equipment furnished and WORK performed for a period of one (1) year from the date of SUBSTANTIAL COMPLETION. The CONTRACTOR warrants and guarantees for a period of one (1) year from the date of SUBSTANTIAL COMPLETION of the system that the completed system is free from all defects due to faulty materials or workmanship and the CONTRACTOR shall promptly make such corrections as may be necessary by

reason of such defects including the repairs of any damage to other parts of the system resulting from such defects. The OWNER will give notice of observed defects with reasonable promptness. In the event that the CONTRACTOR should fail to make such repairs, adjustments, or other WORK that may be made necessary by such defects, the OWNER may do so and charge the CONTRACTOR the cost thereby incurred. The Performance BOND shall remain in full force and effect through the guarantee period.

30. ARBITRATION

30.1 All claims, disputes and other matters in question arising out of, or relating to the CONTRACT DOCUMENTS or the breach thereof, except for claims which have been waived by the making and acceptance of final payment as provided by Section 20, shall be decided by arbitration in accordance with the Construction Industry Arbitration Rules of the American Arbitration Association. This agreement to arbitrate shall be specifically enforceable under the prevailing arbitration law. The award rendered by the arbitrators shall be final, and judgment may be entered upon it in any court having jurisdiction thereof.

30.2 Notice of the demand for arbitration shall be filed in writing with the other party to the CONTRACT DOCUMENTS and with the American Arbitration Association, and a copy shall be filed with the ENGINEER. Demand for arbitration shall in no event be made on any claim, dispute or other matter in question which would be barred by the applicable statute of limitations.

30.3 The CONTRACTOR will carry on the WORK and maintain the progress schedule during any arbitration proceedings, unless otherwise mutually agreed in writing.

31. TAXES

31.1 The CONTRACTOR will pay all sales, consumer, use and other similar taxes required by the law of the place where the WORK is performed.

"General Decision Number: IL20230017 06/02/2023

Superseded General Decision Number: IL20220017

State: Illinois

Construction Types: Heavy and Highway

Counties: Bond, Calhoun, Clinton, Greene, Jersey, Macoupin, Madison, Monroe, Montgomery, St Clair and Washington Counties in Illinois.

MACOUPIN (upper 1/2) & MONTGOMERY (upper 1/2, INCLUDING WAGGONER, STANDARD CITY, & NORTH THEREOF) COUNTIES:

HEAVY CONSTRUCTION PROJECTS (including Sewer & Water Line Construction & Drainage Projects) & HIGHWAY CONSTRUCTION PROJECTS (excluding tunnels, building structures in rest area projects, and railroad construction; bascule, suspension & spandrel arch bridges; bridges designed for commercial navigation; bridges involving marine construction, other major bridges).

Note: Contracts subject to the Davis-Bacon Act are generally required to pay at least the applicable minimum wage rate required under Executive Order 14026 or Executive Order 13658. Please note that these Executive Orders apply to covered contracts entered into by the federal government that are subject to the Davis-Bacon Act itself, but do not apply to contracts subject only to the Davis-Bacon Related Acts, including those set forth at 29 CFR 5.1(a)(2)-(60).

If the contract is entered into on or after January 30, 2022, or the contract is renewed or extended (e.g., an option is exercised) on or after January 30, 2022:	<ul style="list-style-type: none">. Executive Order 14026 generally applies to the contract.. The contractor must pay all covered workers at least \$16.20 per hour (or the applicable wage rate listed on this wage determination, if it is higher) for all hours spent performing on the contract in 2023.
If the contract was awarded on or between January 1, 2015 and January 29, 2022, and the contract is not renewed or extended on or after January 30, 2022:	<ul style="list-style-type: none">. Executive Order 13658 generally applies to the contract.. The contractor must pay all covered workers at least \$12.15 per hour (or the applicable wage rate listed on this wage determination, if it is higher) for all hours spent performing on that contract in 2023.

The applicable Executive Order minimum wage rate will be adjusted annually. If this contract is covered by one of the Executive Orders and a classification considered necessary for performance of work on the contract does not appear on this

wage determination, the contractor must still submit a conformance request.

Additional information on contractor requirements and worker protections under the Executive Orders is available at <http://www.dol.gov/whd/govcontracts>.

Modification Number	Publication Date
0	01/06/2023
1	01/20/2023
2	03/03/2023
3	03/17/2023
4	04/07/2023
5	06/02/2023

CARP0270-015 05/01/2017

	Rates	Fringes
CARPENTER.....	\$ 32.15	25.97
PILEDRIVERMAN.....	\$ 33.15	25.97

CARP0270-023 05/15/2020

GREENE COUNTY

	Rates	Fringes
CARPENTER.....	\$ 35.05	28.57
PILEDRIVERMAN.....	\$ 35.05	28.57

CARP0500-001 05/01/2021

CLINTON, MONROE, and WASHINGTON COUNTIES

	Rates	Fringes
Carpenter & Piledrivermen.....	\$ 41.36	18.90

CARP0500-003 05/01/2021

ST. CLAIR COUNTY

	Rates	Fringes
Carpenter and Piledriver.....	\$ 41.36	18.90

CARP0664-003 05/01/2021

MADISON COUNTY

	Rates	Fringes
Carpenter and Piledriver.....	\$ 41.36	18.90

CARP0664-006 05/01/2021

BOND, CALHOUN, and JERSEY COUNTIES

	Rates	Fringes
CARPENTER.....	\$ 41.36	18.90

ELEC0146-012 06/01/2022

MONTGOMERY COUNTY (East of Butler Grove, Grisham, Hillsboro & Raymond Twps)

	Rates	Fringes
ELECTRICIAN.....	\$ 41.00	20.68

ELEC0193-003 06/01/2022		

MACOUPIN (Barr, Girard, Nilwood, North & South Otter, North & South Palmyra and Virden Twps), AND MONTGOMERY (Bois D' Arc, Harvel and Pitman Twps) COUNTIES

	Rates	Fringes
ELECTRICIAN.....	\$ 39.36	5%+18.95

ELEC0193-011 04/03/2023		

MACOUPIN (Townships of Scottville, North Palmyra, North Otter, Virden, Girard, Barr, South Palmyra, South Otter, and Nilwood) and MONTGOMERY (Townships of Bois D'Arc, Pitman, and Harvel) COUNTIES

	Rates	Fringes
Line Construction		
Groundman - Equipment Operator (Class I, all crawler type equipment larger than D-4, 15 ton crane or larger).....	\$ 54.21	29.5%+7.00
Groundman - Truck Driver (with winch, may operate diggers, 5th wheel type trucks, crawler-type equipment, D-4 and smaller, backhoe 3/4 yard and under, rubber tire and crawler w/end loader, and may drive bucket truck and live boom type line trucks).	\$ 41.10	29.5%+7.00
Groundman - Truck Driver (without winch).....	\$ 38.71	29.5%+7.00
Groundman (Class A).....	\$ 36.82	29.5%+7.00
Lineman & Substation Tech...	\$ 60.34	29.5%+7.00

* ELEC0309-002 12/05/2022

BOND (Westside), CLINTON, GREENE (ALL WORK PERFORMED ON THE ILLINOIS POWER COMPANY PROPERTY), JERSEY (ALL WORK PERFORMED ON THE ILLINOIS POWER COMPANY PROPERTY), MACOUPIN (EXCEPT North 1/3 & Southwest Corner), MADISON (EXCEPT East ALTON, ALTON, WOOD RIVER & HARTFORD), MONROE, MONTGOMERY (East of ROUNDTREE, IRVING & East FORK TWP.), RANDOLPH (PORTION OF RED BUD TOWNSHIP), ST. CLAIR, and WASHINGTON (OKAWVILLE & VENEDY TWPS.) COUNTIES

Rates	Fringes
-------	---------

LINE CONSTRUCTION

Cable Splicer; Lineman		
Welder.....	\$ 63.79	42.15%
Groundman Equipment		
Operator.....	\$ 52.84	42.15%
Groundman Truck Driver.....	\$ 43.13	42.15%
Groundman.....	\$ 39.45	42.15%
Lineman.....	\$ 60.75	42.15%

 ELEC0309-003 08/30/2021

BOND (Western Half), CLINTON (EXCLUDES HUEY, HOFFMAN, & VIC.), MACOUPIN (EXCLUDES BRIGHTON TWP., ATHENVILLE, SCOTTVILLE, GIRARD & AREA N. THEREOF), MADISON (EXCLUDES ALTON, E. ALTON, HARTFORD & WOOD RIVER), MONROE, MONTGOMERY (WEST OF BUTLER GROVE, GRISHAM, HILLSBOROUGH & RAYMOND TWPS), ST. CLAIR and WASHINGTON (VENEDY TWP) COUNTIES

	Rates	Fringes
ELECTRICIAN.....	\$ 43.09	57.96%

 ELEC0649-002 01/06/2020

CALHOUN, GREENE, JERSEY, MACOUPIN (SOUTHWEST CORNER), AND MADISON (E. ALTON, ALTON, WOOD RIVER & HARTFORD) COUNTIES

	Rates	Fringes
Line Construction		
BLASTER.....	\$ 53.45	29%+9.25
EQUIPMENT OPERATOR.....	\$ 45.78	29%+9.25
GROUNDMAN - TRUCK DRIVER		
W/WINCH.....	\$ 34.18	29%+9.25
GROUNDMAN - TRUCK DRIVER		
WO/WINCH.....	\$ 30.18	29%+9.25
GROUNDMAN.....	\$ 29.38	29%+9.25
LINEMAN; AND LINEMAN HOLE		
BORING MACHINE OPERATOR.....	\$ 53.45	29%+9.25

 ELEC0649-008 01/03/2022

CALHOUN, GREEN, JERSEY, MACOUPIN (SOUTHWEST CORNER), AND MADISON (ALTON, E. ALTON, HARTFORD & WOOD RIVER) COUNTIES

	Rates	Fringes
ELECTRICIAN.....	\$ 46.34	25.30

 ELEC0702-002 01/02/2023

ALEXANDER, CLAY, CRAWFORD, EDWARDS, EFFINGHAM, FRANKLIN, FAYETTE (Excludes portion North Avena), GALLATIN, HAMILTON, HARDIN, JACKSON, JASPER, JEFFERSON, JOHNSON, LAWRENCE, MARION, MASSAC, PERRY, POPE, PULASKI, RANDOLPH (Except Red Bud Twps), RICHLAND, SALINE, UNION, WABASH, WAYNE, WHITE, AND WILLIAMSON COUNTIES;

CLARK, COLES (Southern Half), CUMBERLAND, MOULTRIE (Whitley TWP), and SHELBY (Except West of Holland, Prairie, Richland, & Windsor TWPS) COUNTIES;

BOND (Eastern Half), and WASHINGTON (OKAWVILLE & VENDY TWPS) COUNTIES

	Rates	Fringes
Line Construction		
Groundman - Class A.....	\$ 35.64	29%+8.35
Groundman - Equipment Operator Class II (all other equipment).....	\$ 43.40	29%+8.35
Heavy - Equipment Operator Class I (all crawler type equipment D-4 and larger)...	\$ 48.67	29%+8.35
Lineman.....	\$ 61.16	29%+8.35

ELEC0702-017 01/01/2023

BOND (Eastern Half), CLINTON (Huey, Hoffman, & Vicinity), AND
WASHINGTON (Except Venedy TWP) COUNTIES

	Rates	Fringes
ELECTRICIAN.....	\$ 47.90	27.76

ENGI0520-005 08/01/2022

	Rates	Fringes
POWER EQUIPMENT OPERATOR		
Group 01.....	\$ 42.45	34.95
Group 02.....	\$ 41.32	34.95
Group 03.....	\$ 36.84	34.95
Group 04.....	\$ 43.45	34.95
Group 05.....	\$ 44.45	34.95
Group 06.....	\$ 45.00	34.95
Group 07.....	\$ 45.30	34.95
Group 08.....	\$ 45.60	34.95
Group 09.....	\$ 46.25	34.95
Group 10.....	\$ 46.75	34.95
Group 11.....	\$ 44.45	34.95
Group 12.....	\$ 45.45	34.95

POWER EQUIPMENT OPERATOR CLASSIFICATIONS

GROUP 1: Cranes, Draglines, Shovels, Skimmer Scoops, Clamshells or Derrick Boats, Pile Drivers, Crane-Type Backhoes, Asphalt Plant Operators, Concrete Plant Operators, Dredges, Asphalt Spreading Machines, Screws on Asphalt Spreading Machines, All Locomotives, Cable Ways or Tower Machines, Hoists, Hydraulic Backhoes, Ditching Machines, or Backfiller, Cherrypickers, overhead Cranes, Roller, Steam or Gas, Concrete Pavers, Excavator Concrete Breakers, Concrete Pumps, Bulk Cement Plants, Cement Pumps, DerrickType Drills, Boat Operators, Motor Graders or Pushcats, Scoops or Toumapulls, Bulldozers, Endloaders or Fork Lifts, Power Blade or Elevating Graders, Winch Cats, Boom or Winch Trucks or Boom Tractors, Pipe Wrapping or Painting Machines, Asphalt Plant Engineer, Journeyman Lubricating Engineer, Drills (other than derrick type), Mud Jacks, or Well Drilling Machines, Boring Machines or Track Jacks, Mixers, Conveyors (two), Air Compressors (two) Water Pumps, regardless of size (two), Welding Machines (two), Siphons or Jets (two), Winch Head or Apparatuses (two), Light Plants (two), Waterblasters (two), all Tractors, regardless of size (straight tractor only), Fireman on

Stationary Boilers, Automatic Elevators, Form Grading Machines, Finishing Machines, Power Sub-Grader or Ribbon Machines, Longitudinal Floats, Distributor Operators on Trucks, Winch Heads or Apparatuses (one), Mobil Track air and heaters (two to five), Heavy Equipment Greaser, Relief Operator, Assistant Master Mechanic and Heavy Duty Mechanic, concrete saws of all types and sizes with their attachments, gobhoppers, excavators all sizes, the repair, greasing, and fueling of all diesel hammers, the operation, set-up and cleaning of bidwells, concrete placement booms, the alterations, repair of all barges, water blasters of all sizes and their clutches, mobile lifts, hydraulic jacks where used for hoisting, diesel or gas powered flashing signs used for traffic control, micro pavers, log skidders, iceolators used on and off of pipeline, condor cranes, drill rigs of all sizes, bow boats, survey boats, ross carriers, bob-cats and all their attachments, skid steer loaders and all their attachments, creter crane, direct drive electric motors the bolting and unbolting the adjusting and shimming, (dewatering jobs, whirley crane, conveyor belts) etc., batch plants (all sizes), roto mills, conveyors systems of any size and any configuration, hydroseeders and strawblowers all sizes, operation, repair, service of all vibratory hammers, all power pacs and their controls regardless of location, curtains or brush burning machines, stump cutter machines, grout machines regardless of size, Nail launchers when mounted on a machine or self-propelled, con-cover machines, Goldhofer and similar S.P.M.T. (self-propelled modular transpmiers) heavy transport units and all Operators (except those listed below).

Group 2: Assistant Operators

GROUP 3: Air Compressor One; Water Pump regardless of size One; Welding Machine One; 1-Bag Mixer One; Conveyor One; Siphon or Jet; Light Plant One; Heater One; Immobile Track Air One

GROUP 4: Firemen on Whirlies and Asphalt Spreader Oiler; Heavy Equipment Oilers; Truck Cranes; Monigans; Large over 65 tons capacity; Concrete Plant Oiler and Black Top Plant Oiler

GROUP 5: Oilers

GROUP 6: Operators on equipment with Booms, including Jibs, 100 ft and over, but less than 150 ft

GROUP 7: Operators on equipment with Booms, including Jibs, 150 ft and over, but less than 200 ft

GROUP 8: Operators on equipment with Boomns, including Jibs, 200 ft and over; Tower Cranes, and Whirley Cranes

GROUP 9: Certified crane Operators, Below 17.5 tons, when requested by the Contractor or required by the Owner.

GROUP 10: Certified crane Operators 17.5 tons and above, when requested by the Contractor or required by the Owner.

GROUP 11: Master Mechanic

GROUP 12: Licensed Boat Pilot

INCLUDING BUILDING CONSTRUCTION ON HEAVY INDUSTRIAL SITES &
 HEAVY CONSTRUCTION EXCEPT DREDGING AND RIVER WORK

	Rates	Fringes
POWER EQUIPMENT OPERATOR		
Group 01.....	\$ 42.45	34.95
Group 02.....	\$ 41.32	34.95
Group 03.....	\$ 36.84	34.95
Group 04.....	\$ 43.45	34.95
Group 05.....	\$ 44.45	34.95
Group 06.....	\$ 45.00	34.95
Group 07.....	\$ 45.30	34.95
Group 08.....	\$ 45.60	34.95
Group 09.....	\$ 46.25	34.95
Group 10.....	\$ 46.75	34.95
Group 11.....	\$ 44.45	34.95
Group 12.....	\$ 45.45	34.95

POWER EQUIPMENT OPERATOR CLASSIFICATIONS

GROUP 1: Cranes, Draglines, Shovels, Skimmer Scoops, Clamshells or Derrick Boats, Pile Drivers, Crane-Type Backhoes, Asphalt Plant Operators, Concrete Plant Operators, Dredges, Asphalt Spreading Machines, Screws on Asphalt Spreading Machines, All Locomotives, Cable Ways or Tower Machines, Hoists, Hydraulic Backhoes, Ditching Machines, or Backfiller, Cherrypickers, overhead Cranes, Roller, Steam or Gas, Concrete Pavers, Excavator Concrete Breakers, Concrete Pumps, Bulk Cement Plants, Cement Pumps, Derrick-Type Drills, Boat Operators, Motor Graders or Pushcats, Scoops or Tournapulls, Bulldozers, Endloaders or Fork Lifts, Power Blade or Elevating Graders, Winch Cats, Boom or Winch Trucks or Boom Tractors, Pipe Wrapping or Painting Machines, Asphalt Plant Engineer, Journeyman Lubricating Engineer, Drills (other than derrick type), Mud Jacks, or Well Drilling Machines, Boring Machines or Track Jacks, Mixers, Conveyors (two), Air Compressors (two) Water Pumps, regardless of size (two), Welding Machines (two), Siphons or Jets (two), Winch Head or Apparatuses (two), Light Plants (two), Waterblasters (two), all Tractors, regardless of size (straight tractor only), Fireman on Stationary Boilers, Automatic Elevators, Form Grading Machines, Finishing Machines, Power Sub-Grader or Ribbon Machines, Longitudinal Floats, Distributor Operators on Trucks, Winch Heads or Apparatuses (one), Mobil Track air and heaters (two to five), Heavy Equipment Greaser, Relief Operator, Assistant Master Mechanic and Heavy Duty Mechanic, concrete saws of all types and sizes with their attachments, gob-hoppers, excavators all sizes, the repair, greasing, and fueling of all diesel hammers, the operation, set-up and cleaning of bidwells, concrete placement booms, the alterations, repair of all barges, water blasters of all sizes and their clutches, mobile lifts, hydraulic jacks where used for hoisting, diesel or gas powered flashing signs used for traffic control, micro pavers, log skidders, iceolators used on and off of pipeline, condor cranes, drill rigs of all sizes, bow boats, survey boats, ross carriers, bob-cats and all their attachments, skid steer loaders and all their attachments, creter crane, direct drive electric motors the bolting and unbolting the

adjusting and shimming, (dewatering jobs, whirley crane, conveyor belts) etc., batch plants (all sizes), roto mills, conveyors systems of any size and any configuration, hydroseeders and straw-blowers all sizes, operation, repair, service of all vibratory hammers, all power pacs and their controls regardless of location, curtains or brush burning machines, stump cutter machines, grout machines regardless of size, Nail Launchers when mounted on a machine or self-propelled, con-cover machines, Goldhofer and similar S.P.M.T. (self-propelled modular transporters) heavy transport units and all Operators (except those listed below).

GROUP 2: Assistant Operators

GROUP 3: Air Compressors (one), Water Pumps, regardless of size (one), Water-blasters (one), Welding Machine (one), Mixers (one bag), Conveyor (one), Siphon or Jet (one), Light Plant (one), Heater (one), Immobile Track Air (one), and Self-Propelled Walk Behind Rollers.

GROUP 4: Fireman on Whirlies and Heavy Equipment Oilers, Truck Cranes, Dredges, Monigans, Large Cranes - (Over 65-ton rated capacity) Concrete Plant Oiler, Blacktop Plant oiler and Creter Crane Oiler (when required), barge tenders, oilers on drill rigs used for caisson or for pile driving.

GROUP 5: Oilers

GROUP 6: Operators on equipment with Booms, including Jibs, 100 ft and over, but less than 150 ft

GROUP 7: Operators on equipment with Booms, including Jibs, 150 ft and over, but less than 200 ft

GROUP 8: Operators on equipment with Boomns, including Jibs, 200 ft and over; Tower Cranes, and Whirley Cranes

GROUP 9: Certified crane Operators, Below 17.5 Tons, when requested by the Contractor or required by the Owner

GROUP 10: Celiified crane Operators 17.5 Tons and above, when requested by the Contractor or required by the Owner

GROUP 11: Master Mechanic

GROUP 12: Licensed Boat Pilot

 * IRON0046-006 05/01/2023

GREENE (NORTHERN HALF), MACOUPIN (NORTH OF SUMMERVILLE), AND MONTGOMERY (NORTH OF LITCHFIELD & HILLSBORO) COUNTIES

	Rates	Fringes
IRONWORKER.....	\$ 36.84	31.64

 IRON0392-003 08/01/2022

BOND, CALHOUN, CLINTON, GREENE (SOUTHERN HALF), JERSEY, MACOUPIN (SUMMERVILLE & SOUTH THEREOF), MADISON, MONROE, MONTGOMERY (LITCHFIELD, HILLSBORO, & SOUTH THEREOF), ST. CLAIR,

and WASHINGTON COUNTIES

	Rates	Fringes
IRONWORKER.....	\$ 38.80	29.53

IRON0396-006 01/02/2012		

BRIDGES, LOCKS, and DAMS ON THE MISSISSIPPI RIVER

	Rates	Fringes
IRONWORKER.....	\$ 31.98	19.11

LAB00044-001 08/01/2022		

MADISON COUNTY (Southwest)

	Rates	Fringes
LABORER		
Group 1.....	\$ 29.35	31.38
Group 2.....	\$ 29.85	31.38
Group 3.....	\$ 30.85	31.38

LABORER CLASSIFICATIONS:

GROUP 1 - General Laborer

GROUP 2 - Asbestos Abatement Worker and Hazardous Waste Worker; Lead Base Paint Worker; Mason and Plasterer Tender

GROUP 3 - Dynamite Man and Powder Man

LAB00044-002 08/01/2022

MADISON COUNTY (GLEN CARBON)

	Rates	Fringes
LABORER		
GROUP 1.....	\$ 29.35	31.38
GROUP 2.....	\$ 29.85	31.38
GROUP 3.....	\$ 30.85	31.38

LABORERS CLASSIFICATIONS

GROUP 1 - General Laborers.

GROUP 2 - Brick Mason and Plasterer Tenders; Asbestos Abatement Worker, Hazardous Waste Worker

GROUP 3 - Dynamite and Powder Men.

LAB00100-001 08/01/2022

ST CLAIR COUNTY (East St. Louis, Alcoa, Brooklyn, Cahokia, Caseyville, Centreville, Dupo, Fairmont City, French Village, Midway, Maplewood, National City)

Rates Fringes

LABORERS		
Group 1.....	\$ 33.43	27.30
Group 2.....	\$ 33.93	27.30
Group 3.....	\$ 34.93	27.30

LABORER CLASSIFICATIONS:

GROUP 1 - General Laborer

GROUP 2 - Asbestos Abatement Worker and Hazardous Waste Worker; Lead Base Paint Worker, Hod Carrier

GROUP 3 - Dynamite Man

LAB00196-001 08/01/2022

MONROE COUNTY

	Rates	Fringes
LABORERS		
Group 1.....	\$ 30.31	30.42
Group 2.....	\$ 30.81	30.42
Group 3.....	\$ 31.81	30.42

LABORER CLASSIFICATIONS:

GROUP 1 - General Laborer

GROUP 2 - Asbestos Abatement Worker and Hazardous Waste Worker; Lead Base Paint Worker

GROUP 3 - Dynamite Man and Powder Man

LAB00218-001 08/01/2022

BOND (Greeneville), CALHOUN (Hardin), GREENE (Roadhouse), JERSEY (Jerseyville), and MADISON (Alton) COUNTIES

	Rates	Fringes
LABORERS		
Group 1.....	\$ 32.84	27.89
Group 2.....	\$ 33.34	27.89
Group 3.....	\$ 34.34	27.89

LABORER CLASSIFICATIONS:

GROUP 1 - General Laborer

GROUP 2 - Asbestos Abatement Worker and Hazardous Waste Worker; Lead Base Paint Worker

GROUP 3 - Dynamite Man and Powder Man

LAB00218-004 08/01/2022

JERSEY COUNTY (Jerseyville)

Rates	Fringes
-------	---------

LABORER		
GROUP 1.....	\$ 32.84	27.89
GROUP 2.....	\$ 33.34	27.89
GROUP 3.....	\$ 34.34	27.89

LABORER CLASSIFICATIONS

- GROUP 1 - General Laborers.
- GROUP 2 - Brick Mason and Plasterer Tenders.
- GROUP 3 - Dynamite and Powder Men.

LAB00218-005 08/01/2022

GREENE COUNTY (Roadhouse)

	Rates	Fringes
LABORER		
GROUP 1.....	\$ 32.84	27.89
GROUP 2.....	\$ 33.34	27.89
GROUP 3.....	\$ 34.34	27.89

LABORER CLASSIFICATIONS

- GROUP 1 - General Laborers.
- GROUP 2 - Brick Mason and Plasterer Tenders.
- GROUP 3 - Dynamite and Powder Men.

LAB00218-006 08/01/2022

CALHOUN COUNTY (Hardin)

	Rates	Fringes
LABORER		
GROUP 1.....	\$ 32.84	27.89
GROUP 2.....	\$ 33.34	27.89
GROUP 3.....	\$ 34.34	27.89

LABORERS CLASSIFICATIONS

- GROUP 1 - General Laborers.
- GROUP 2 - Brick Mason and Plasterer Tenders.
- GROUP 3 - Dynamite and Powder Men.

LAB00338-002 08/01/2021

MADISON COUNTY (Wood River)

	Rates	Fringes
LABORERS		
Group 1.....	\$ 30.75	28.14
Group 2.....	\$ 31.25	28.14
Group 3.....	\$ 32.25	28.14

LABORER CLASSIFICATIONS:

GROUP 1 - General Laborer

GROUP 2 - Asbestos Abatement Worker and Hazardous Waste Worker; Lead Base Paint Worker

GROUP 3 - Dynamite Man and Powder Man

LAB00397-001 08/01/2022

MADISON COUNTY (Southeast)

	Rates	Fringes
LABORERS		
Group 1.....	\$ 33.43	27.30
Group 2.....	\$ 33.93	27.30
Group 3.....	\$ 34.93	27.30

LABORER CLASSIFICATIONS:

GROUP 1 - General Laborer

GROUP 2 - Asbestos Abatement Worker and Hazardous Waste Worker; Lead Base Paint Worker

GROUP 3 - Dynamite Man

LAB00397-002 08/01/2022

MADISON COUNTY (GRANITE CITY and Vicinity)

	Rates	Fringes
LABORERS		
Group 1.....	\$ 33.58	27.30
Group 2.....	\$ 34.08	27.30
Group 3.....	\$ 35.08	27.30

LABORER CLASSIFICATIONS:

GROUP 1 - General Laborer

GROUP 2 - Asbestos Abatement Worker and Hazardous Waste Worker; Lead Base Paint Worker

GROUP 3 - Dynamite Man

LAB00397-003 08/01/2022

MADISON COUNTY (Edwardsville, Marine, and Livingston)

	Rates	Fringes
LABORER		
GROUP 1.....	\$ 33.58	27.30
GROUP 2.....	\$ 34.08	27.30
GROUP 3.....	\$ 35.08	27.30

LABOREER CLASSIFICATIONS

GROUP 1 - General Laborers.

GROUP 3 - Brick Mason and Plasterer Tenders.

GROUP 4 - Dynamite and Powder Men.

LAB00459-001 08/01/2022

ST. CLAIR COUNTY (South)

	Rates	Fringes
LABORERS		
Group 1.....	\$ 31.64	29.09
Group 2.....	\$ 32.14	29.09
Group 3.....	\$ 33.14	29.09

LABORER CLASSIFICATIONS:

GROUP 1 - General Laborer

GROUP 2 - Asbestos Abatement Worker and Hazardous Waste Worker; Lead Base Paint Worker

GROUP 3 - Dynamite Man

LAB00459-004 08/01/2022

ST. CLAIR COUNTY (Belleville)

	Rates	Fringes
Hod Carrier.....	\$ 31.64	29.09

LAB00581-002 08/01/2022

CLINTON COUNTY (Carlyle)

	Rates	Fringes
LABORERS		
Group 1.....	\$ 29.09	31.64
Group 2.....	\$ 29.59	31.64
Group 3.....	\$ 30.59	31.64

LABORER CLASSIFICATIONS:

GROUP 1 - General Laborer

GROUP 2 - Asbestos Abatement Worker and Hazardous Waste Worker; Lead Base Paint Worker

GROUP 3 - Dynamite and Powder Man

LAB00622-002 08/01/2022

BOND COUNTY (Greenville)

	Rates	Fringes
LABORERS		

Group 1.....	\$ 28.09	32.64
Group 2.....	\$ 28.59	32.64
Group 3.....	\$ 29.59	32.64

LABORER CLASSIFICATIONS:

GROUP 1 - General Laborer

GROUP 2 - Asbestos Abatement Worker and Hazardous Waste Worker; Lead Base Paint Worker

GROUP 3 - Dynamite Man

LAB00622-003 08/01/2022

BOND COUNTY (Except the Northside)

	Rates	Fringes
LABORERS		
GROUP 1.....	\$ 28.09	32.64
GROUP 2.....	\$ 28.59	32.64
GROUP 3.....	\$ 29.59	32.64

LABORER CLASSIFICATIONS

GROUP 1 - General Laborer

GROUP 2 - Asbestos Abatement Worker and Hazardous Waste Worker; Lead Base Paint Worker

GROUP 3 - Dynamite Man

LAB00670-001 08/01/2021

ST CLAIR (O'Fallon, Scott Air Force Base, Shiloh, Lebanon & Vicinity), CLINTON (Trenton & Vicinity), and MADISON (Troy) COUNTIES

	Rates	Fringes
LABORERS		
Group 1.....	\$ 28.84	30.05
Group 2.....	\$ 29.34	30.05
Group 3.....	\$ 30.34	30.05

LABORER CLASSIFICATIONS:

GROUP 1 - General Laborer

GROUP 2 - Asbestos Abatement Worker and Hazardous Waste Worker; Lead Base Paint Worker

Group 3 - Dynamite Man

LAB00670-004 08/01/2021

MADISON COUNTY (St. Jacob)

Rates	Fringes
-------	---------

LABORER

GROUP 1.....	\$ 28.84	30.05
GROUP 2.....	\$ 29.34	30.05
GROUP 3.....	\$ 30.34	30.05

LABORER CLASSIFICATIONS

GROUP 1 - General Laborers.

GROUP 2 - Brick Mason and Plasterer Tenders.

GROUP 3 - Dynamite and Powder Men.

LAB00674-001 08/01/2002

MADISON COUNTY (St. Jacob)

	Rates	Fringes
LABORER		
GROUP 1.....	\$ 29.45	1.60
GROUP 2.....	\$ 29.70	1.60
GROUP 3.....	\$ 29.95	1.60
GROUP 4.....	\$ 29.45	1.60

LABORER CLASSIFICATIONS

GROUP 1 - General Laborers.

GROUP 2 - Work in Septic tanks, cess pools, or dry wells (old or new); All feeders, mixers and nozzle men on gunnite or sandblasting work; When handling creosoted material; Raking or luting asphalt; Burning or cutting with torch; Working on Bottom of Sewer Trenches on Final Grading, Laying or Caulking of performed sectional Sewer Pipe; High time (20 feet or over) where exposed to an open fall; Operator of motor buggies; Any work performed in or on all types of cased wells; Cooking, mixing and applying of mastic such as sulfa-seal and/or other coal derivatives

GROUP 3 - Brick Mason and Plasterer Tenders.

GROUP 4 - Dynamite and Powder Men.

LAB00742-001 08/01/2022

ST. CLAIR (Mascoutah) and CLINTON (New Baden) COUNTIES

	Rates	Fringes
LABORERS		
Group 1.....	\$ 29.26	31.47
Group 2.....	\$ 29.76	31.47
Group 3.....	\$ 30.76	31.47

LABORER CLASSIFICATIONS:

GROUP 1 - General Laborer

GROUP 2 - Asbestos Abatement Worker and Hazardous Waste Worker; Lead Base Paint Worker

GROUP 3 - Dynamite Man

LAB00968-001 08/01/1997

CALHOUN COUNTY (Hardin)

	Rates	Fringes
LABORER		
GROUP 1.....	\$ 25.80	.60
GROUP 2.....	\$ 26.05	.60
GROUP 3.....	\$ 26.30	.60
GROUP 4.....	\$ 27.325	.60

LABORERS CLASSIFICATIONS

- GROUP 1 - General Laborers.
- GROUP 2 - Work in Septic tanks, cess pools, or dry wells (old or new); All feeders, mixers and nozzle men on gunnite or sandblasting work; When handling creosoted material; Ranking or luting asphalt; Burning or cutting with torch; Working on Bottom of Sewer Trenches on Final Grading, Laying or Caulking or performed sectional Sewer Pipe; High time (20 feet or over) where exposed to an open fall; Operator of motor buggies; Any work performed in or on all types of cased wells; Cooking, mixing and applying of mastic such as sulfa-seal and/or other coal derivatives
- GROUP 3 - Brick Mason and Plasterer Tenders.
- GROUP 4 - Dynamite and Powder Men.

LAB01084-001 08/01/2022

BOND (Sorento) and MONTGOMERY COUNTIES

	Rates	Fringes
LABORERS		
Group 1.....	\$ 29.41	31.32
Group 2.....	\$ 29.91	31.32
Group 3.....	\$ 30.91	31.32

LABORER CLASSIFICATIONS:

- GROUP 1 - General Laborer
- GROUP 2 - Asbestos Abatement Worker and Hazardous Waste Worker; Lead Base Paint Worker
- GROUP 3 - Dynamite Man

PAIN0058-002 05/01/2017

	Rates	Fringes
PAINTER (Bridge).....	\$ 32.45	17.12
Epoxy or Toxic-Lead-Based Paint Work-\$1.00 Premium		

PLAS0090-001 08/01/2018

BOND, CALHOUN, CLINTON (WESTERN HALF EAST TO BUT NOT INCLUDE CARYLE), GREENE, JERSEY, MACOUPIN, MADISON, MONROE, MONTGOMERY, and ST. CLAIR COUNTIES

	Rates	Fringes
CEMENT MASON/CONCRETE FINISHER...	\$ 34.50	24.75

PLAS0090-005 08/01/2018		

Clinton County

	Rates	Fringes
CEMENT MASON/CONCRETE FINISHER...	\$ 34.50	24.75

PLAS0143-007 04/01/2016		

WASHINGTON COUNTY

	Rates	Fringes
CEMENT MASON/CONCRETE FINISHER...	\$ 36.43	20.87

TEAM0050-006 05/01/2020		

BOND. CLINTON, MONROE, ST CLAIR, WASHINGTON COUNTIES

	Rates	Fringes
TRUCK DRIVER		
Group 1.....	\$ 39.04	20.63
Group 2.....	\$ 39.60	20.63
Group 3.....	\$ 39.91	20.63
Group 4.....	\$ 40.25	20.63
Group 5.....	\$ 41.33	20.63

CLASSIFICATIONS:

GROUP 1: Drivers on 2 axles hauling less than 9 tons; air compressor & welding machines and brooms, including those pulled by separate units; Truck Driver Helper, warehouse employees; Mechanic Helpers; greasers and tiremen; pick-up trucks when hauling material, tools, or workers to and from and on the job site; and forklifts up to 6,000 lb capacity.

GROUP 2: 2 or 3 axles hauling more than 9 tons but hauling less than 16 tons; A-frame winch trucks; hydrolift trucks; Vector Trucks or similar equipment when used for transportation purposes; Forklift over 6,000 lb.capacity; winch trucks; and four axle combination units.

GROUP 3: 2, 3 or 4 Axles hauling 16 tons or more; 5-Axles or more combination units; drivers on water pulls; articulated dump trucks; mechanics and working forepersons.

GROUP 4: Low Boy and Oil Distributors.

GROUP 5: Drivers who require special protective clothing while employed on hazardous waste work.

TEAM0525-004 05/01/2019

CALHOUN, GREENE (South of a direct line that extends East from Pike County through Hillview/Whitehall to Macoupin County), JERSEY, MACOUPIN, MADISON, MONTGOMERY COUNTIES

	Rates	Fringes
TRUCK DRIVER		
Group 1.....	\$ 38.17	19.85
Group 2.....	\$ 38.71	19.85
Group 3.....	\$ 39.01	19.85
Group 4.....	\$ 39.34	19.85
Group 5.....	\$ 40.39	19.85

CLASSIFICATIONS:

GROUP 1: Drivers on 2 axles hauling less than 9 tons; air compressor & welding machines and brooms, including those pulled by separate units; Truck Driver Helper, warehouse employees; Mechanic Helpers; greasers and tiremen; pick-up trucks when hauling material, tools, or workers to and from and on the job site; and forklifts up to 6,000 lb capacity.

GROUP 2: 2 or 3 axles hauling more than 9 tons but hauling less than 16 tons; A-frame winch trucks; hydrolift trucks; Vector Trucks or similar equipment when used for transportation purposes; Forklift over 6,000 lb.capacity; winch trucks; and four axle combination units.

GROUP 3: 2, 3 or 4 Axles hauling 16 tons or more; 5-Axles or more combination units; drivers on water pulls; articulated dump trucks; mechanics and working forepersons.

GROUP 4: Low Boy and Oil Distributors.

GROUP 5: Drivers who require special protective clothing while employed on hazardous waste work.

TEAM0916-004 05/01/2019

GREENE (North of a direct line that extends East from Pike County through Hillview/Whitehall to Macoupin County) COUNTY

	Rates	Fringes
TRUCK DRIVER		
Group 1.....	\$ 38.17	19.85
Group 2.....	\$ 38.71	19.85
Group 3.....	\$ 39.01	19.85
Group 4.....	\$ 39.34	19.85
Group 5.....	\$ 40.39	19.85

CLASSIFICATIONS:

GROUP 1: Drivers on 2 axles hauling less than 9 tons; air compressor & welding machines and brooms, including those pulled by separate units; Truck Driver Helper, warehouse employees; Mechanic Helpers; greasers and tiremen; pick-up trucks when hauling material, tools, or workers to and from and on the job site; and forklifts up to 6,000 lb capacity.

GROUP 2: 2 or 3 axles hauling more than 9 tons but hauling less than 16 tons; A-frame winch trucks; hydrolift trucks;

Vactor Trucks or similar equipment when used for transportation purposes; Forklift over 6,000 lb.capacity; winch trucks; and four axle combination units.

GROUP 3: 2, 3 or 4 Axles hauling 16 tons or more; 5-Axles or more combination units; drivers on water pulls; articulated dump trucks; mechanics and working forepersons.

GROUP 4: Low Boy and Oil Distributors.

GROUP 5: Drivers who require special protective clothing while employed on hazardous waste work.

WELDERS - Receive rate prescribed for craft performing operation to which welding is incidental.

=====
Note: Executive Order (EO) 13706, Establishing Paid Sick Leave for Federal Contractors applies to all contracts subject to the Davis-Bacon Act for which the contract is awarded (and any solicitation was issued) on or after January 1, 2017. If this contract is covered by the EO, the contractor must provide employees with 1 hour of paid sick leave for every 30 hours they work, up to 56 hours of paid sick leave each year. Employees must be permitted to use paid sick leave for their own illness, injury or other health-related needs, including preventive care; to assist a family member (or person who is like family to the employee) who is ill, injured, or has other health-related needs, including preventive care; or for reasons resulting from, or to assist a family member (or person who is like family to the employee) who is a victim of, domestic violence, sexual assault, or stalking. Additional information on contractor requirements and worker protections under the EO is available at <https://www.dol.gov/agencies/whd/government-contracts>.

Unlisted classifications needed for work not included within the scope of the classifications listed may be added after award only as provided in the labor standards contract clauses (29CFR 5.5 (a) (1) (ii)).

The body of each wage determination lists the classification and wage rates that have been found to be prevailing for the cited type(s) of construction in the area covered by the wage determination. The classifications are listed in alphabetical order of ""identifiers"" that indicate whether the particular rate is a union rate (current union negotiated rate for local), a survey rate (weighted average rate) or a union average rate (weighted union average rate).

Union Rate Identifiers

A four letter classification abbreviation identifier enclosed in dotted lines beginning with characters other than ""SU"" or ""UAVG"" denotes that the union classification and rate were prevailing for that classification in the survey. Example: PLUM0198-005 07/01/2014. PLUM is an abbreviation identifier of the union which prevailed in the survey for this

classification, which in this example would be Plumbers. 0198 indicates the local union number or district council number where applicable, i.e., Plumbers Local 0198. The next number, 005 in the example, is an internal number used in processing the wage determination. 07/01/2014 is the effective date of the most current negotiated rate, which in this example is July 1, 2014.

Union prevailing wage rates are updated to reflect all rate changes in the collective bargaining agreement (CBA) governing this classification and rate.

Survey Rate Identifiers

Classifications listed under the "SU" identifier indicate that no one rate prevailed for this classification in the survey and the published rate is derived by computing a weighted average rate based on all the rates reported in the survey for that classification. As this weighted average rate includes all rates reported in the survey, it may include both union and non-union rates. Example: SULA2012-007 5/13/2014. SU indicates the rates are survey rates based on a weighted average calculation of rates and are not majority rates. LA indicates the State of Louisiana. 2012 is the year of survey on which these classifications and rates are based. The next number, 007 in the example, is an internal number used in producing the wage determination. 5/13/2014 indicates the survey completion date for the classifications and rates under that identifier.

Survey wage rates are not updated and remain in effect until a new survey is conducted.

Union Average Rate Identifiers

Classification(s) listed under the UAVG identifier indicate that no single majority rate prevailed for those classifications; however, 100% of the data reported for the classifications was union data. EXAMPLE: UAVG-OH-0010 08/29/2014. UAVG indicates that the rate is a weighted union average rate. OH indicates the state. The next number, 0010 in the example, is an internal number used in producing the wage determination. 08/29/2014 indicates the survey completion date for the classifications and rates under that identifier.

A UAVG rate will be updated once a year, usually in January of each year, to reflect a weighted average of the current negotiated/CBA rate of the union locals from which the rate is based.

WAGE DETERMINATION APPEALS PROCESS

1.) Has there been an initial decision in the matter? This can be:

- * an existing published wage determination
- * a survey underlying a wage determination
- * a Wage and Hour Division letter setting forth a position on a wage determination matter
- * a conformance (additional classification and rate) ruling

On survey related matters, initial contact, including requests

for summaries of surveys, should be with the Wage and Hour National Office because National Office has responsibility for the Davis-Bacon survey program. If the response from this initial contact is not satisfactory, then the process described in 2.) and 3.) should be followed.

With regard to any other matter not yet ripe for the formal process described here, initial contact should be with the Branch of Construction Wage Determinations. Write to:

Branch of Construction Wage Determinations
Wage and Hour Division
U.S. Department of Labor
200 Constitution Avenue, N.W.
Washington, DC 20210

2.) If the answer to the question in 1.) is yes, then an interested party (those affected by the action) can request review and reconsideration from the Wage and Hour Administrator (See 29 CFR Part 1.8 and 29 CFR Part 7). Write to:

Wage and Hour Administrator
U.S. Department of Labor
200 Constitution Avenue, N.W.
Washington, DC 20210

The request should be accompanied by a full statement of the interested party's position and by any information (wage payment data, project description, area practice material, etc.) that the requestor considers relevant to the issue.

3.) If the decision of the Administrator is not favorable, an interested party may appeal directly to the Administrative Review Board (formerly the Wage Appeals Board). Write to:

Administrative Review Board
U.S. Department of Labor
200 Constitution Avenue, N.W.
Washington, DC 20210

4.) All decisions by the Administrative Review Board are final.

=====
END OF GENERAL DECISIO"

STANDARD SPECIFICATIONS

(Reference)

- 1) **The Standard Specifications for Road and Bridge Construction**, referred to herein are those prepared by the Department of Transportation of the State Illinois, Adopted January 1, 2022.
- 2) **The Standard Specifications for Water and Sewer Main Construction in Illinois**, July 2009, Sixth Edition, referred to herein, are those prepared by the Standards Specifications Committee and distributed by the Illinois Society of Professional Engineers.
- 3) Any reference to ASTM Designations refers to Standards and Specifications of the American Society for Testing and Materials, latest edition.
- 4) General Conditions, Article 19, Payments to Contractor Subarticle 19.1, that portion of Article 19.1 which states the owner will, within 10 days of presentation to him of an approved partial payment estimate, pay the approved partial payment estimate. That reference to 10 days shall be changed to read 60 days, thus, the Owner will pay the Contractor within 60 days upon receipt of an approved partial payment estimate from the engineer pending receipt of funds from the funding agency.
- 5) The Detailed Specifications contained herein shall supplement these specifications; and, in case of conflict, the Detailed Specifications shall take precedence and shall govern.
- 6) Any reference to measurement and payment within cited references shall not apply.

INDEX OF PLANS

1	Cover Sheet & General Notes
2	327 N. 63 rd Street Plan & Profile
3	310 N. 73 rd Street Plan & Profile
4	Miscellaneous Details

All plan sheets are bound herein

**SANITARY SEWER REPAIR
TWO LOCATIONS
CAHOKIA HEIGHTS**

1. GENERAL

1.1 DESCRIPTION

Base Bid: The project consists of furnishing all labor, materials, and equipment for the replacement of approximately 40 lineal feet of 8-inch diameter sewer, including clearing, dewatering, care of flow, cleaning & televising, and approximately 567 lineal feet of Cured-In-Place Pipe (CIPP) liner, together with reestablishment of service connections, restoration of all disturbed surfaces, and all other incidental work required to complete the project.

1.2 CONTRACTOR'S DUTIES

- A. Except as specifically noted, Contractor shall provide and pay for:
 - 1. All labor, materials, and equipment used for construction of and/or incorporated into the project.
 - 2. All tools, construction equipment, and machinery.
 - 3. Required building permits, and all inspection fees by governmental authorities.
 - 4. Other facilities and services necessary for proper execution and completion of work.

- B. Owner is exempt from sales tax on products permanently incorporated in work.
 - 1. Obtain sales tax exemption certificate number from Owner.
 - 2. Place exemption certificate number on invoices for materials incorporated in work.
 - 3. Upon completion of work, file with Owner a notarized statement that all purchases made under exemption certificate were entitled to be exempt and furnish copies of invoice to Owner.
 - 4. Pay legally assessed penalties for improper use of exemption certificate number.

- C. Give required notice.

- D. Comply with codes, ordinances, rules, regulations, orders, and other legal requirements of public authorities which bear on performance of work.

- E. Promptly submit written notice to Architect/Engineer of observed variance of contract documents from legal requirements.
 - 1. It is not Contractor's responsibility to make certain that drawings and specifications comply with codes and regulations.
 - a. Appropriate modifications to contract documents will account for/reflect necessary changes.
 - b. Assume responsibility for work known to be contrary to such requirements if written notice is not provided by the Contractor to the Architect/Engineer.

- F. Enforce strict discipline and good order among employees.

1.3 CONTRACTOR USE OF PREMISES

- A. Confine operations at site to areas permitted by:
 - 1. Law.
 - 2. Ordinances.
 - 3. Permits.
 - 4. Contract Documents.
- B. Do not unreasonably encumber site with materials or equipment.
- C. Do not load structure with weight that will endanger structure.
- D. Assume full responsibility for protection and safe-keeping of products stored on premises.
- E. Move any stored products which interfere with operations of Owner or other contractors.
- F. Obtain and pay for use of additional storage or work areas needed for operations.
- G. Contractor shall have limited use of site for execution of work.
 - 1. Allow for public use of all adjoining streets and sidewalks.

1.4 OTHER FACILITIES AND SERVICES

- A. Contractor shall maintain adjacent buildings free from entrance of water at all times during construction.
- B. Contractor shall furnish, erect and maintain temporary ladders, ramps or hoists as may be required for performance of his work.
 - 1. All such equipment shall be substantially designed, constructed and maintained in accordance with applicable federal, state, and local laws, ordinances, and regulations, and shall be promptly removed when no longer needed.

1.5 CONTRACT DOCUMENTS

- A. Contractor will be furnished free of charge three (3) copies of drawings and specifications.
- B. On request, additional copies will be furnished to Contractor at cost of reproduction, postage and handling.

END 01010.

1. GENERAL

1.1 SUMMARY

- A. Piezometers have been installed at the following locations to provide ground water information in the vicinity of the sanitary sewer repair locations:
 - 1. Piezometer GP 1 - 200 N. 74th Street (at Edna Street)
 - 2. Piezometer GP 8 - 5504 Lake Drive (across from 5505 Lake Drive)
- B. Copies of the following additional project information is included in this section:
 - 1. Piezometer Readings
- C. The piezometer readings contained herein are presented for general information. The groundwater monitoring information has been conducted in accordance with standard practices and procedures. The results of these monitoring activities represent the subsurface conditions at the specific locations and dates indicated. Subsurface conditions between these locations and on differing dates may vary. The information provided herein is not intended as a substitute for the personal investigation, independent interpretation, and judgment of the contractor.

END 01031

**PIEZOMETER READINGS
CITY OF CAHOKIA HEIGHTS**

Piezometer GP 8
5504 Lake Drive
(across from 5505 Lake Drive)

PIEZOMETER READINGS		
<small>(GROUND ELEVATION 414)</small>		
DATE	DEPTH	ELEVATION
12/15/22	7	407
01/01/23	8	406
01/15/23	8	406
02/01/23	8	406
02/15/23	8	406
03/01/23	8	406
03/15/23	7	407
04/01/23	6	408
04/15/23	7	407
05/01/23	8	406
AVERAGE	8	407

DIVISION 1 - GENERAL REQUIREMENTS
Section 01051 - Grades, Lines & Levels

1. GENERAL

1.1 REQUIREMENTS INCLUDE

- A. Contractor shall lay out the work under his contract.
 - 1. Establish all working lines, levels, elevations and measurements.

1.2 RELATED REQUIREMENTS

- A. By others:
 - 1. Architect/Engineer will furnish:
 - a. Topographic survey of site, giving all grades and lines boundaries and contours of building site.
 - b. Title information regarding:
 - 1) Easements.
 - 2) Other restrictions.
 - c. Benchmark and temporary benchmark location and elevation of each.

1.3 QUALITY ASSURANCE

- A. Qualifications of Engineer/Surveyor:
 - 1. Experienced in layout work of similar complexity.

END 01051

1. GENERAL
- 1.1 REQUIREMENTS INCLUDE
- A. Contractor:
1. Provide, operate and maintain equipment, services and personnel, with traffic control and protective devices, to expedite vehicular traffic flow on on-site haul routes, at site entrances, on-site access roads and parking areas.
 2. Remove temporary equipment and facilities when no longer required.
 3. Restore grounds to original conditions.
- 1.2 REFERENCES. Specified references, or cited portions thereof, current at date of bidding documents unless otherwise noted.
- A. Illinois Department of Transportation (IDOT): Standard Specifications for Road and Bridge Construction, including all addenda.
- 1.3 TRAFFIC SIGNS
- A. Provide and operate traffic control signs to direct and maintain an orderly flow of traffic in all areas under Contractor's control.
- B. Provide traffic control and directional signs, mounted on barricades or standard posts:
1. At each change of direction of a roadway.
 2. At each crossroads.
 3. At detours.
 4. At parking areas.
- 1.4 FLAGMEN. Each Contractor shall provide qualified and suitably equipped flagmen when construction operations encroach on traffic lanes, as required for traffic regulation.
- 1.5 FLARES AND LIGHTS
- A. Provide flares and lights during periods of low visibility:
1. To clearly delineate traffic lanes and to guide traffic.
 2. For use by flagmen in directing traffic.
- B. Provide illumination of critical traffic and parking areas.
- 1.6 CONSTRUCTION PARKING CONTROL
- A. Control vehicular parking to preclude interference with public traffic or parking, access by emergency vehicles, Owner's operations or construction operations.

- B. Monitor parking of construction personnel's private vehicles:
 - 1. Maintain free vehicular access to and through parking areas.
 - 2. Prohibit parking on or adjacent to access roads, or in non-designated areas.

1.7 HAUL ROUTES

- A. Consult with Architect/Engineer and Owner. Establish public thoroughfares which will be used as haul routes and site access.
- B. Confine construction traffic to designated haul routes.

1.8 TRAFFIC CONTROL

- A. All traffic control shall be in accordance with Section 701 of the Standard Specifications and Highway Standards 701301, 701501 and 701901.

END 01570

DIVISION 2 - SITE WORK
Section 02102 - Clearing and Site Preparation

1. GENERAL

1.1 WORK INCLUDES

A. Base Bid:

1. General Contractor:

- a. Clearing and removing surface debris.
- b. Removal of designated paving, curbs and sidewalks.
- c. Removal and disposal of debris and unsuitable material.

1.2 REFERENCES. Specified references, or cited portions thereof, current at date of bidding documents unless otherwise specified, govern the work.

- A. Illinois Department of Transportation (IDOT): Standard Specifications for Road and Bridge Construction, including all addenda.

2. PRODUCTS

Not Used

3. EXECUTION

3.1 INSPECTION

- A. Before beginning work, properly locate and verify all present underground utilities and other related existing improvements and protect same wherever they may be encountered in the proposed sewer repair.
- B. Maintain all benchmarks, monuments and other reference points. If disturbed or destroyed, restore as directed by Engineer.
- C. No clearing shall be started until the Contractor has established limits of work and until the Engineer has inspected the site with the Contractor and has given definite instructions as to the limits of clearing. Prior to removal of any tree not specified to be removed on the drawings, obtain Engineer's approval.

3.2 SEWER REPAIR

- A. Clearing and tree removal shall be in accordance with Section 201 of the Standard Specifications.
- B. Removal of existing pavement and appurtenances shall be in accordance with Section 440 of the Standard Specifications. The limits of removal shall be as specified or shown on drawings.

3.4 MATERIAL DISPOSAL

- A. Broken pavement, utility lines and other unsuitable material shall be disposed of by the Contractor off the project site in accordance with all local and state codes.

END 02102

DIVISION 2 - SITE WORK
Section 02222 - Excavating, Backfilling &
Compacting for Utilities

1. GENERAL

1.1 WORK INCLUDES

A. Contractor provide:

1. All excavation, backfilling, compacting, disposal of surplus material, restoration of all disturbed surfaces, and all other work incidental to the construction of trenches, including any additional excavation which may be required for other structures forming a part of the pipe line.
2. Tree and bush removal is considered incidental to the cost of the various types and sizes of pipe installation.
3. Compacted bed and compacted fill over utilities to subgrade elevations.
4. Compaction.

1.2 REFERENCES. Specified references, or cited portions thereof, current at date of bidding documents unless otherwise specified, govern the work. References to measurement and basis of payment made in any cited reference do not apply.

A. American Society for Testing and Materials (ASTM):

1. ASTM D-1557: Tests for moisture density relationship of soils and soil aggregate mixtures using 10 lb. rammer and 18-inch drop.
2. ASTM D-2922-91 and D-3017-88: Tests for determining density and moisture of soil in place by nuclear methods.

B. Standard Specifications for Water and Sewer Main Construction in Illinois, Sixth Edition, July 2009.

C. Illinois Department of Transportation (IDOT): Standard Specifications for Road and Bridge Construction, including all addenda.

1.3 SUBMITTALS

A. Submit 20 lb. samples of each type of fill material to be used. Forward samples to testing laboratory packed tightly in separate containers to prevent contamination.

B. When recent test results are available for fill materials to be used, disregard samples submission and submit the test results to the testing laboratory. Test results shall clearly indicate material types, composition, hardness, compactibility and suitability for proposed usage.

1.4 PROTECTION

A. Protect excavations by shoring, bracing, sheet piling, underpinning or other methods to prevent cave-in or loose soil from falling into excavation.

B. Underpin adjacent structures which may be damaged by excavation work, including

service utilities and pipe chases.

- C. Notify Architect/Engineer immediately of unexpected subsurface conditions. Confirm notification in writing. Discontinue work until Architect/Engineer issues written notification to resume work.
- D. Protect bottom of excavations and soil adjacent to and beneath structures from frost.
- E. Grade excavation top perimeter to prevent surface water runoff into excavation.
- F. Trees, shrubs, fences and all other property and surface structures shall be protected during construction unless their removal is called for in the contract documents. All properties destroyed shall be restored to original conditions.

2. PRODUCTS

2.1 SELECT BEDDING AND FILL MATERIALS

- A. Granular bedding shall be in accordance with Section 20 of the Standard Specifications for Water and Sewer Main Construction in Illinois.
- B. Granular backfill shall be in accordance with Section 20 of the Standard Specifications for Water and Sewer Main Construction in Illinois, and shall be IDOT CA 6.
- C. Select soil (common fill) shall be native soil excavated from trench free of rocks, frozen earth and foreign material.

3. EXECUTION

3.1 INSPECTION

- A. Verify stockpiled fill to be reused as approved in writing by Architect/Engineer.
- B. Verify and confirm in writing that areas to be backfilled are free of debris, snow, ice or water, and surfaces are not frozen.

3.2 PREPARATION

- A. Identify specified lines, levels, contours and data.
- B. Prior to excavation, investigation shall be made to the extent necessary to determine the location of existing underground structures, utilities and conflicts. Include in contract all costs associated with locating and identifying all underground utilities, structures and obstructions.

3.3 EXCAVATION

- A. Excavate subsoil: For piping or conduit.
 - 1. Contractor (as necessary) for:
 - a. Sanitary sewer lines.

- B. Cut trenches wide enough to enable utility installation and allow inspection. Trench widths for water and sewer lines shall be in accordance with Section 20 of the Standard Specifications for Water and Sewer Main Construction in Illinois.
- C. Hand trim excavation and leave free of loose matter as required for proper pipe bedding and thrust block bearing area.
- D. Excavation shall not interfere with normal 45 degree bearing splay of foundations.
- E. Fill over-excavated areas under pipe or conduit bearing surfaces in accord with Architect/Engineer's directions.

3.4 BACKFILLING

- A. Support pipe during placement and compaction of bedding fill.
- B. Backfill trenches to contours and elevations shown and/or to allow surface drainage. Backfill systematically, as early as possible to allow maximum time for natural settlement. Do not backfill over porous, wet or spongy subgrade surfaces.
- C. Place and compact granular bedding in continuous layers not exceeding 12 inches loose depth and compact to 95% Standard Proctor Density.
- D. Place and compact granular backfill and common fill material in continuous layers not exceeding 12 inches loose depth to a point 12 inches above the top of the pipe and compact to 90% Standard Proctor Density.
- E. Use a placement method that will not disturb or damage foundation perimeter drainage, foundation waterproofing and protective cover or utilities in trenches.
- F. Maintain optimum moisture content of backfill materials, determined by laboratory analysis, to obtain specified compaction density.
- G. Remove surplus backfill materials from site.
- H. Leave stockpile areas completely free of excess fill materials.
- I. Dewater pipe trench to eliminate spongy wet trench bottom.
- J. Excavate to depths as required to avoid deflecting pipe and joints beyond manufacturer's recommended limits.
- K. Stockpile excavated material in a manner that will not endanger the work or obstruct access to other utilities, sidewalks, drives and roadways.
- L. Provide 6 inches of granular bedding on all sides of pipe where large rocks and large boulders are encountered.
- M. Do not excavate more than what can be backfilled in one day.
- N. Should the trench pass over previous excavation, the trench bottom shall be sufficiently compacted to provide support equal to that of native soil so as to prevent

damage to the pipe.

- O. Burial depths are measured from the top of the pipe barrel to the ground surface.
- P. Backfilling in unimproved areas from an elevation of one foot above the top of pipe to the surface of the ground may be deposited by bulldozer or other suitable equipment. Sufficient surplus excavated material shall be neatly rounded over the trench to compensate for later settlement.
- Q. Backfilling under existing roads, parking areas, other improved surfaces or at locations shown on the drawings shall be entirely aggregate for trench backfill. From a depth of one foot above the top of pipe to the surface, granular backfill may be deposited in uniform layers not to exceed 12 inches loose measure and compacted to 95% of the Standard Proctor Density.
- R. When rock is encountered, the rock removed may be used as part of the backfill material; but fine material must first be filled from the bottom of the trench to at least 12 inches over the barrel of the pipe. When rock is used for backfill, it shall be well distributed so that each rock shall be completely surrounded by earth. Location of rock fills shall be noted as Record Construction Drawings.
- S. Backfilling shall not be done in freezing weather without the permission of the Architect/Engineer, and it shall not be made with frozen materials. No backfill shall be made where the materials already in the trench are frozen.

3.5 SAFETY

- A. All local, federal and state rules and regulations pertaining to safety and protection of workmen, public and private property shall be observed during all work.

END 02222

1. GENERAL

1.1 REQUIREMENTS INCLUDE

A. Contractor provide:

1. Dewatering of excavation to allow construction of sewers, manholes, and appurtenances in the dry and with firm excavation walls and foundation.
2. Bypass of flowing sewer mains around the excavation site to downstream manholes.

2. EXECUTION

2.1 DEWATERING:

- A. The Contractor shall install and operate a suitable dewatering system to allow all work related to the construction of the sewer mains to be accomplished in the dry and with firm excavation walls and foundation. Water which has accumulated in excavated areas shall be removed by the Contractor. The dewatering system shall be installed prior to beginning excavation activities and shall be of such type and operated in such a manner so as not to remove material from the foundation or wall area of the excavation. All dewatering and related equipment and materials shall be and remain the Contractor's property and, when no longer required, shall be removed in their entirety from the site. Any holes shall be backfilled with material similar to that of the adjacent area and compacted to the density of the material surrounding the hole. Dewatering facilities to be constructed under this Contract shall be included in the base bid.

2.2 SEWER BYPASS:

- A. Sewer flows shall be maintained at all times and shall be in accordance with local health and sanitary requirements. Pumping, temporary connections or other suitable methods of diversion shall be employed so that the flow of sewage shall not be interrupted.
- B. Sewage flows will be intercepted where indicated on the drawings at existing manholes and bypass pumped as directed by the Engineer. The Contractor will be required to furnish pumping equipment, conduits, and other equipment required to maintain flow without causing overflows backups, surges or any other abnormal flow conditions.
- C. When bypass pumps are in use, they shall be monitored by the Contractor at all times.
- D. Bypass pumping will be performed such that existing sewer lines are never placed under more than 3 feet of hydraulic head as measured from the sewer invert at the pump location.
- E. Individual service laterals encountered during construction shall be diverted to the nearest downstream manhole. The cost of such diversion will be considered incidental to the construction of the sewer and shall be included in the base bid.

END 02400.

1. GENERAL

1.1 REQUIREMENTS INCLUDE

A. Contractor:

1. Provide all materials, labor and equipment for seeding and mulching all disturbed areas of excavation and all other disturbed areas within the construction limits that will not be resurfaced.

1.2 REFERENCES. Specified references or cited portions thereof, current at date of bidding documents unless otherwise specified, govern the work. References to measurement and basis of payment made in any cited reference do not apply.

- A. Illinois Department of Transportation (IDOT): Standard Specifications for Road and Bridge Construction, including all addenda.

2. PRODUCTS

2.1 MATERIALS

- A. All seeding materials shall be in accordance with Sections 250, 251 and 1081 of the IDOT Standard Specifications.
- B. The seed mixture shall be Class 1 - Lawn Mixture in accordance with Article 250.07 of the IDOT Standard Specifications.

3. EXECUTION

3.1 SOIL PREPARATION

- A. After all trenches have been backfilled; the areas to be seeded shall be prepared in accordance with Article 250.05 of the IDOT Standard Specifications.

3.2 FERTILIZER

- A. Fertilizer nutrient shall be a 10-10-10 proportion applied at the rate of 270 pounds per acre. This is the weight of the nutrient only and does not include the weight of the filler material. The fertilizer shall conform to Article 1081.08 of the IDOT Standard Specifications.

3.3 SEEDING

- A. The rate of application shall be 100 pounds/acre in accordance with Article 250.07 IDOT Standard Specifications. The area shall be continuously reseeded until a sound turf is established.
- B. Seeding equipment and construction operations shall be in accordance with Section 250.03 of the IDOT Standard Specifications.

3.4 MULCHING

- A. All seeded areas shall be mulched. Mulching materials, equipment and construction operations shall be in accordance with Section 251 of the IDOT Standard Specifications. Mulch shall be applied uniformly to all seeded areas at the rate of two tons per acre by Method 1 as described in Article 251.03 of the IDOT Standard Specifications.

END 02480

DIVISION 2 - SITE WORK
Section 02610 - Pipe & Pipe Fittings
Sewer

1. GENERAL

1.1 WORK INCLUDES

- A. Base Bid:
 - 1. Contractor provide:
 - a. Sanitary sewer lines and services.

1.2 QUALITY ASSURANCE

- A. PVC gravity sewer pipe and fittings shall conform to ASTM D-3034 (minimum SDR26). All pipe shall be manufactured from clear virgin resin cell classification 12454B conforming to ASTM D1784.

1.3 PRODUCT DELIVERY, STORAGE AND HANDLING

- A. Transport, deliver, unload, store and handle all pipe and fittings in a manner to prevent damage to the materials or the work.
- B. All damaged, broken or otherwise defective materials will be rejected.
- C. Store all circular rubber gaskets and special lubricants in packaged materials with the manufacturer's name, brand and all other applicable data plainly marked thereon.

2. PRODUCTS

2.1 SANITARY SEWER PIPING, BURIED BEYOND 5 FEET OF BUILDING

- A. PVC Pipe: ASTM D-3034, SDR 26, PSM.
 - 1. Fittings: ASTM D-3034, PVC.
 - 2. Joints: ASTM F477, elastomeric gaskets.

3. EXECUTION

3.1 COORDINATION

- A. The Contractor shall schedule work and notify the District in ample time so that provisions for their work can be made without delaying the progress of the project.

3.2 INSTALLATION

- A. General:
 - 1. All installations shall conform to lines and grade as shown on the drawings. Valves and special fittings shall be placed where shown on the drawings unless their location is changed by the Architect/Engineer. In the event field conditions dictate deviation from the drawings, no change shall be made without written authorization of the Architect/Engineer.

2. No pipe shall be laid in water or when, in the opinion of the Architect/Engineer, trench conditions are unsuitable. When pipe laying is stopped at night or for any other reason, watertight plugs shall be used to exclude dirt, water and small animals.
3. Prior to starting work, the Contractor shall arrange to have the manufacturer furnish initial instructions in the proper assembly and installation of the pipe. Such instructions shall in no way be construed to assume all or any part of the Contractor's or Architect/Engineer's responsibility for proper design, installation or inspection.
4. All pipe, fittings and accessories shall be carefully placed into the trench by suitable equipment in such manner as to prevent damage to pipe and fittings.
5. In distributing the material at the site of the work, each piece shall be unloaded opposite or near the place where it is to be laid in the trench. All pipe shall be loaded and unloaded piecemeal by hand or in bundles by lifting with hoists or skidding so as to avoid shock or damage. Under no circumstances shall such materials be dropped. Pipe handled on skidways shall not be skidded or rolled against pipe already on the ground.

B. Trench Excavation and Pipe Bedding:

1. All excavation shall be made by open cut. The sides of the trench shall be kept as nearly vertical as possible, especially from the trench floor to the level of one foot above the top of the pipe.
2. Trenches shall be excavated to a depth that will provide a covering of not less than 3'-6" or as shown on the drawings, measured from the top of the pipe barrel to the final grade elevation. Trench bottoms shall have a minimum width of the pipe plus 18 inches.
3. All excavated material shall be deposited adjacent to the trench for ease of backfilling. Excavated materials shall be deposited so as to be of as little inconvenience as possible to construction activities.
4. The Contractor shall furnish, put in place and maintain such sheathing, bracing, etc., as may be required to support the sides of the excavation and to prevent any movement which might injure personnel, damage the pipe or delay the work.
5. Bedding for PVC pipeline, as shown on the drawings, shall consist of natural, sandy material shaped and compacted for uniform support of the pipe. A minimum of six inches shall be placed between the bottom of the pipe and the bottom of the trench.

C. Laying of Pipe:

1. Proper implements, tools (jack-type tool and bell sling) and facilities satisfactory to the Architect/Engineer shall be provided and used by the Contractor for the safe and convenient prosecution of the work.
2. Before any length of pipe is placed in the trench, a careful inspection shall be made of the interior of the pipe to see that no foreign material is in the pipe. In order to properly remove any foreign material, a swab of necessary length is to be available at all times.
3. All pipe shall be lowered carefully into the trench, properly aligned and properly jointed by use of suitable tools and equipment, in such a manner as to prevent damage to materials and protective coatings and linings.
4. Under no circumstances shall pipe materials be dropped or dumped into the trench. The pipe and fittings shall also be inspected for the purpose of determining if they are sound and free from cracks. Laying of pipe shall be commenced immediately after excavation is started.
5. Pipe shall be laid with bell ends facing in the direction of laying, unless the main

- is being laid down a steep incline, in which case the bell ends shall face uphill.
6. All lumps, blisters and excess coating shall be removed from the joint of each pipe; and the outside and inside of all joints shall be wire brushed and wiped clean and dry and free from oil and grease before the pipe is laid.
 7. Avoid field cutting of pipe if at all possible. If pipe must be cut in the field, the cut end shall be conditioned so that it can be used to make up the next joint. Bevel the outside of the cut 3/16-inch to 1/4- inch at an angle of approximately 30 degrees to prevent damage to the gasket.

D. Jointing:

1. Remove all foreign matter from the socket, making sure the gasket seat is clean.
2. The gasket shall be wiped clean with a clean cloth, flexed and properly placed in the socket for a snug fit in the retainer seat.
3. Apply lubricant furnished by the pipe manufacturer on the surface of the gasket, which will come in contact with the plain end of the pipe to be laid.
4. Clean the plain end of the pipe and apply a thin film of lubricant about one inch back from the end. Keep pipe free of ground or trench sides to avoid foreign matter from clinging to the lubricant.
5. The plain end of the pipe should be aligned and carefully entered into the socket until it just makes contact with the gasket. This is the starting position for the final assembly of the joint.
6. Joint assembly should then be completed by jacking the plain end of the entering pipe past the gasket (which is thereby compressed) until it makes contact with the bottom of the socket. A system of marking the pipe shall be used to make certain the assembled joint is at the proper depth.

E. Laying of Pipe on Curves:

1. Long radius curves, either horizontal or vertical, may be laid with standard pipe by deflections at the joints. If the pipe is shown curved on the drawings and no special fittings are shown, the Contractor can assume that the curves can be made by deflection of the joints with standard lengths of pipe. If shorter lengths are required, the drawings will indicate maximum lengths that can be used.
2. Where field conditions require deflection of curves not anticipated by the drawings, the Architect/Engineer will determine the methods to be used.
3. When rubber gasketed pipe is laid on a curve, the pipe shall be jointed in a straight alignment. Trenches shall be made wider on curves for this purpose.

F. Backfilling:

1. Backfilling under any existing and/or proposed roads, parking areas or other improved surfaces shall be entirely aggregate for trench backfill. From a depth of one foot above the top of pipe to the surface, aggregate for trench backfill may be deposited in uniform layers not to exceed 12 inches loose measure and compacted.
2. All surplus excavated material not required for backfilling the excavation shall be removed from the site.
3. When rock is encountered, the rock removed may be used as part of the backfill material; but fine material must first be filled from the bottom of the trench to at least 12 inches over the barrel of the pipe. When rock is used for backfill, it shall be well distributed so that each rock shall be completely surrounded by earth.

4. Backfilling shall not be done in freezing weather without the permission of the Architect/Engineer, and it shall not be made with frozen materials. No backfill shall be made where the materials already in the trench are frozen.

3.3 TESTING AND INSPECTION

A. Exfiltration Tests (Testing shall be performed by one of the following methods):

1. Sewer lines shall be hydrostatically tested by filling the line with water to a level six feet above the normal water level. Exfiltration shall be limited to a maximum of 100 gallons per inch diameter per mile per day. If no measurable subsidence of the water level has occurred during the first two hours of testing, the line shall be accepted as to exfiltration testing.
2. Sewer lines shall be air tested by pressurizing the line to 3.5 psig above the back pressure of the ground water over the pipe. After a two-minute stabilization period at a pressure of four psig above the ground water level, the minimum time required for the pressure to drop to 2.5 psig shall be measured and shall equal or exceed the time indicated in Section 31-1.13C of the Standard Specifications for Water and Sewer Main Construction in Illinois, Sixth Edition, July 2009.

B. Deflection Tests

1. The entire stretch of pipe being repaired shall be tested. The line shall be tested for excess deflection by pulling a mandrel through the pipe from manhole to manhole. The test shall be performed without mechanical pulling devices. The outside diameter of the test mandrel shall be equal to ninety-five percent (95%) of the base diameter of the pipe as established by ASTM D-3034. The individual line to be tested shall be so tested no sooner than 30 days after it has been installed. Wherever possible and practical, the testing shall initiate at the downstream lines and proceed toward the upstream lines.
2. Where deflection is found to be in excess of 5% of the original pipe diameter, the Contractor shall excavate to the point of excess deflection and carefully compact around the point where excess deflection was found. The line shall then be retested for deflection. If, after the initial testing, the deflected pipe should fail to return to the original size (inside diameter) the line shall be replaced. In the event that deflection occurs beyond the 5% limit in 10% or more of the reaches tested, the entire system shall be tested for deflection.

C. Inspection

1. A visual inspection shall be made of gravity flow lines; and all obstructions shall be removed. Any sewer showing less than one-half the cross sectional area of the pipe between adjacent manholes or other undue deviation from line and grade shall be considered as unsatisfactory and shall be repaired by the Contractor without additional compensation.

END 02610

DIVISION 2 - SITE WORK

Section 02731 - Sewer Cleaning, Main Sewers

1. GENERAL

1.1 REQUIREMENTS INCLUDE

A. Contractor provide:

1. All labor, equipment, materials, plant and supervision to perform all work necessary to clean existing sewers in accordance with these specifications and as shown on the plans.

1.2 DEFINITIONS

- A. The term "Clean" as used in these specifications, shall be defined as removing sufficient material to render the sewer line 99% of its original capacity.
- B. The term "Reach" as used in the specifications, shall mean the length of pipe connecting two manholes.

2. EXECUTION

2.1 GENERAL

A. Hydraulic Cleaning Equipment:

1. The equipment used shall be of a movable dam type and shall be constructed in such a way that a portion of the dam may be collapsed at any time during the cleaning operation to protect against flooding of the sewer. Sewer cleaning balls or other such equipment which cannot be collapsed instantly will not be considered as acceptable cleaning equipment. The movable dam shall be of equal diameter as the pipe being cleaned and shall provide a flexible scraper around the outer periphery to insure total removal of grease. Other equipment which produces the desired end results will be approved by the Engineer.

B. High Velocity Hydro-Cleaning Equipment

1. All high-velocity sewer cleaning equipment shall be truck-mounted for ease of operation. The equipment shall have a minimum of 500 feet of 3/4" I.D. high-pressure hose with a selection of two or more high-velocity nozzles. The nozzles shall have a capacity of 30 GPM at a working pressure of 500 to 1,500 psi. The nozzle shall be capable of producing a scouring action from 15 degrees to 45 degrees in all size lines designated to be cleaned. Equipment shall also include a high velocity gun for washing and scouring manhole walls and floors. The gun capacity shall equal 3 1/2 to 27 GPM at between 800 and 2090 psi. The gun shall be capable of producing flows from a fine spray to a long distance solid stream. The equipment shall carry its own 1,200-gallon water tank capable of holding corrosive or caustic cleaning or sanitizing chemicals, auxiliary engines and pumps, and hydraulically driven hose reel. All controls shall be located so that the equipment can be operated

above ground. Other equipment which produces the desired end result will be approved by the Engineer.

C. Water for Cleaning

1. Water will be available only at those locations designated by the applicable utility company. Water shall be conserved and not wasted. The Contractor will be responsible for acquiring water from the applicable utility and paying for the use of said water. Water will not be measured for payment, but will be considered incidental to sewer line cleaning.

D. Disposal of Material

1. All sludge, dirt, sand, rocks, grease and other solid or semi-solid material removed during the cleaning operation shall be removed at the downstream manhole of the reach being cleaned. Passing material from reach to reach, which could cause line stoppages, accumulations of sand in wetwells or damage to pumping equipment will not be permitted.
2. When hydraulic cleaning equipment is used, a suitable weir or dam shall be constructed in the downstream manhole in such a manner that both the solids and water shall be trapped. This trapped solution shall then be pumped, using a four-inch double diaphragm trash pump, from the manhole into a retention chamber above ground. The retention chamber shall be of a size of not less than 10 feet by 6 feet by 1 foot high and shall be mounted for complete mobility. The chamber shall contain not less than two baffles to ensure complete settlement of the solids before returning the liquid to the sewer line.
3. All solids or semi-solids resulting from the cleaning operations shall be removed from the site and disposed of by the Contractor, as approved by the Engineer. Removal and disposal in compliance with all local health and sanitary requirements and to the approval of the Engineer will be incidental to the cleaning of the sewer lines.

E. Final Acceptance of Cleaning

1. Any damage to sanitary sewers resulting from the cleaning operations shall be the responsibility of the Contractor, and necessary repairs shall be made by the Contractor at no additional expense to the Owner. Final acceptance of this portion of the work shall be made upon completion of the television inspection and shall be to the entire satisfaction of the Engineer.

END 02731.

DIVISION 2 - SITE WORK
Section 02732 - Television Inspection,
Main Sewers

1. GENERAL

1.1 REQUIREMENTS INCLUDE:

A. Contractor provide:

1. Television inspection of sewers is to be conducted only after sewer rehabilitation and cleaning have been accomplished.

2. EXECUTION

2.1 GENERAL

A. Television Inspection, Main Sewers:

1. The sewer sections shall be visually inspected by means of closed-circuit television. The inspection will be done one manhole section at a time and the flow in the section being inspected will be suitably controlled as specified.
2. The television camera used for the inspection shall be one specifically designed and constructed for such inspection. Lighting for the camera shall be suitable to allow a clear picture of the entire periphery of the pipe. The camera shall be operative in 100% humidity conditions. The camera, television monitor, videotape recorder, and other components of the video system shall be capable of producing picture quality to the satisfaction of the Owner's Representative; and if unsatisfactory, the equipment shall be removed and no payment will be made for an unsatisfactory inspection.
3. The camera shall be moved through the line in either direction at a moderate rate, stopping when necessary to permit proper documentation of the sewer's condition. In no case will the television camera be pulled at a speed greater than 30 feet per minute. Manual winches, power winches, TV cable, and powered rewinds or other devices that do not obstruct the camera view or interfere with proper documentation of the sewer conditions shall be used to move the camera through the sewer line. If, during the inspection operation, the television camera will not pass through the entire manhole section, the Contractor shall set up his own equipment so that the inspection can be performed from the opposite manhole. If, again, the camera fails to pass through the entire manhole section, the inspection shall be considered complete and no additional inspection will be required.
4. When manually operated winches are used to pull the television camera through the line, telephones or other suitable means of communication shall be set up between the two manholes of the section being inspected to insure good communications between members of the crew.
5. The importance of accurate distance measurements is emphasized. Measurement for location of defects shall be above ground by means of

a meter device. Marking on the cable, or the like, which would require interpolation for depth of manhole, will not be allowed. Accuracy of the distance meter shall be checked by use of a walking meter, roll-a-tape, or other suitable device, and the accuracy shall be satisfactory to the Owner's Representative.

B. Documentation of the television results shall be as follows:

1. Television Inspection Logs: Printed location records shall be kept by the Contractor and will clearly show the location in relation to an adjacent manhole. In addition, other points of significance such as locations of building sewers and other discernible features will be recorded and a copy of such records will be supplied to the Owner.
2. Digital Format Video Recordings: The purpose of video recordings shall be to supply a visual and audio record of problem areas of the lines that may be replayed. The videotape shall be a CD or DVD with a high quality picture and sound and shall be recorded in color. The video shall have an on-screen display showing the following:
 - a. Upstream and downstream manhole numbers.
 - b. Footage from the upstream manhole.
 - c. Date of inspection.
3. Two copies of the inspection logs and video recordings of all inspections shall be furnished to the Owner.

END 02732.

1. GENERAL

1.1 REQUIREMENTS INCLUDE:

A. Contractor provide:

1. Sewer flows through the reaches to be televised, as well as through all tributary sewers, shall be maintained at all times throughout the entire project.
2. A fully operational back-up pump shall be maintained on site at all times for emergencies during care of flow/by-passing operations. The capacity of the back-up pump shall be sufficient to maintain sewer flows.

2. EXECUTION

2.1 CARE OF FLOW

A. General:

1. Sewer flows shall be maintained at all times and shall be in accordance with local health and sanitary requirements by pumping, fluming, temporary connections or by other suitable methods of diversion so that the project will not be delayed nor the flow of sewage interrupted.
2. When sewer line flows are above minimum requirements (generally not more than 1/4 of the pipe diameter) or inspection of the complete periphery of the pipe is necessary to effectively conduct the inspection and sealing operations, one or more of the following methods of flow control shall be used.
3. In order to accomplish the cleaning and television inspection in this contract, normal sewage flows must be maintained. Sewage flows shall be intercepted at existing manholes and restricted or bypass pumped as directed by the Engineer. Where pumping is required, in the opinion of the Engineer, to assure completion of the inspection and lining work, the Contractor will be required to furnish pumping equipment, conduits and other equipment necessary to bypass the sewage flows.
4. The bypass system shall be such that the maximum hydraulic head on the existing sewer line, when measured by the location of the pump, is less than 3.0 feet at all times. The hydraulic head shall be measured from the invert of the sewer.
5. Pumping will not be permitted unless other methods of sewer flow controls prove unsatisfactory for television observation. Bypass pumping for television inspection shall be included in the contract price for the work. Methods of controlling flow other than pumping shall be incidental to the cleaning and televising.

END 02734

1. GENERAL

1.1 REQUIREMENTS INCLUDE

A. Contractor provide:

1. Intent: It is the intent of this specification to provide for the rehabilitation of sanitary sewers by the installation of a resin-impregnated flexible felt tube inserted into the existing pipe using hydrostatic pressure or other means. Curing shall be accomplished by circulating hot water, or other approved method, to cure the resin to a hard, impermeable, corrosion resistant pipe within a pipe.
2. This specification references ASTM standards, which are made a part hereof by reference and shall be the latest edition thereof.
3. Chemical Resistance Requirements: The finished pipe in place shall be fabricated from materials which when cured will meet the chemical resistance guidelines of ASTM F-1216.

1.2 PRODUCT DELIVERY, STORAGE AND HANDLING

- A. Transport, deliver, unload, store and handle all felt tube and fittings in a manner to prevent damage to the materials or the work.
- B. All damaged, broken or otherwise defective materials will be rejected.

2. PRODUCTS

2.1 GENERAL SPECIFICATIONS GOVERNING THE WORK

- A. The materials provided under this section shall conform to ASTM F1216 and the requirements of the CIPP manufacturer.
- B. Installation of CIPP by the "pull-in and inflate" method in accordance with ASTM F1743 is an acceptable alternative to ASTM F1216 for this project.

2.2 MATERIALS

- A. Tube - the sewn tube shall meet the requirements of ASTM F1216, Section 5.1 and shall not contain fiberglass continuous strand matt. The tube shall be constructed to withstand installation pressures, have sufficient strength to bridge missing pipe, stretch to fit irregular pipe sections, and shall install smoothly around bends.
 1. The wetout tubes shall have a uniform thickness that when compressed at installation pressures will meet or exceed the design thickness.
 2. The tube shall be made to a size that when installed will tightly fit the internal circumference and length of the original pipe. Allowance should be made for circumferential stretching during installation.
 3. The outside layer of the tube (before wetout) shall be polyethylene

coated, a translucent flexible material that clearly allows inspection of the resin impregnation (wetout) procedure. The plastic coating shall hold the resin inside the tube without leakage, accommodate installation, stretch to size and shall not delaminate before, during or after curing of the CIPP.

4. The tube shall be homogeneous across the entire wall thickness containing no intermediate or encapsulated elastomeric layers. No material shall be included in the tube that may cause delamination in the cured CIPP. No dry or unsaturated layers shall be evident.
5. The wall color of the interior pipe surface of the CIPP after installation shall be a light reflective color so that a clear detail examination with closed circuit television inspection equipment may be made.
6. Seams in the tube shall be stronger than the unseamed felt. Where the length requires joining, the sewn joint shall not be perpendicular to the long axis but spirally formed and sewn.

B. Resin - The resin system shall be a corrosion resistant polyester, vinyl ester, or epoxy and catalyst system that meets the requirements of ASTM F1216, and the physical properties stipulated herein.

C. Structural Requirements

1. The CIPP shall be designed as per ASTM F1216, Appendix X1. The CIPP design shall assume no bonding to the original pipe wall. The Long-Term Flexural Modulus shall be substantiated by independent lab testing (such as the Trenchless Technology Center at Louisiana Tech University). Such Long-Term Modulus shall not exceed 50% of the short-term values specified herein.
2. The layers of the cured CIPP shall be uniformly bonded. It shall not be possible to separate any two layers with a probe or point of a knife blade so that the layers separate cleanly or the probe or knife blade moves freely between the layers. If separation of the layers occurs during testing of field samples, new samples will be cut from the work. Any reoccurrence may cause rejection of the work.
3. The cured pipe material (CIPP) shall conform to the structural properties, as listed below (if the contractor uses a modulus of elasticity other than 400,000 psi, then design calculations for the proposed system must be submitted for review and approval prior to installation):

Modulus of		
Elasticity	ASTM D790	400,000 psi
Flexural Strength	ASTM D790	4,500 psi

4. The required structural CIPP wall thickness shall be based on the following design parameters.
 - a. Fully deteriorated pipe.
 - b. Design safety factor of 2.0.
 - c. Ovality of 5%.
 - d. Ground water depth = 5 feet above crown of sewer.
 - e. Soil depth (above crown of pipe) = 11 feet.
 - f. Soil modulus = 700 psi.
 - g. Soil density = 120 lb./cu.ft.
 - h. Live load = H20 Highway, 16,000 lbs.

D. Testing Requirements

1. Chemical Resistance - The CIPP shall meet the chemical resistance requirements of ASTM F1216, Appendix XII. CIPP samples for testing shall be of tube and resin system similar to that proposed for actual construction. It is required that CIPP samples with and without plastic coating meet these chemical-testing requirements.
2. Hydraulic Capacity - Overall, the Hydraulic profile shall be maintained as large as possible. The CIPP shall, as a minimum, have the full flow capacity of the original pipe before rehabilitation. Calculated capacities may be derived using a commonly accepted roughness coefficient for the existing pipe material taking into consideration its age and condition. The roughness coefficient of the CIPP shall be verified by third party test data.
3. CIPP Field Samples - When requested by the Engineer, the Contractor shall submit test results from previous field installation in the USA of the same resin system and tube materials as proposed for the actual installation. These test results must verify that the CIPP physical properties specified have been achieved in previous field applications. Testing samples for this project shall be made and tested as specified herein.

3. EXECUTION

3.1 COORDINATION

- A. The Contractor shall schedule work and notify all contractors in ample time so that provisions for their work can be made without delaying the progress of the project.
- B. The Contractor shall make every effort to maintain service usage throughout the duration of the project. In the event that a service will be temporarily out of service, the maximum amount of time of no service shall be 12 hours for any property served by the sewer. The Contractor shall be required to notify the Owner and all affected properties whose service laterals will be out of commission and to advise against water usage until the sewer main is back in service. Such notification shall be provided to the Utility Department at least one week prior to service disconnecting.
- C. Public Notification - A public notification program shall be implemented, and shall as a minimum, require the Contractor to be responsible for contacting each home or business connected to the sanitary sewer and inform them of the work to be conducted, and when the sewer will be off-line. The Contractor shall also provide the following:
 - a. Written notice to be delivered to each home or business describing the work, schedule, how it affects them, and a local telephone number of the Contractor they can call to discuss the project or any problems which could arise.
 - b. Personal contact and attempted written notice the day prior to the beginning of work being conducted on the section relative to the residents affected.

- c. Personal contact with any home or business that cannot be reconnected within the time stated in the written notice.
- D. Preparatory Procedures: The following procedures shall be adhered to unless otherwise approved by the Owner's Representative.
1. Cleaning: It shall be the responsibility of the Contractor to clean the pipeline with a high-pressure water jet of 1,500 to 2,000 psi maximum capacity and to remove internal debris out of the pipeline.
 2. TV Inspection: Inspection shall be performed by experienced personnel. The interior of the pipeline shall be carefully inspected using closed-circuit television or other means to determine conditions, which may prevent proper installation, and it shall be noted so that these conditions can be corrected.
 3. Obstruction Removal: The Contractor shall remove obstructions and intruding service connections that may prevent proper installation.
 4. Flow Control: The Contractor shall provide for the bypassing of sewage entering or passing through the pipe to be rehabilitated.
 5. Line Obstructions: It shall be the responsibility of the Contractor to clear the line of obstructions such as solids and roots that will prevent the installation of CIPP. If pre-installation inspection reveals an obstruction such as a protruding service connection, dropped joint, or a collapse that will prevent the installation process, and it cannot be removed by conventional sewer cleaning equipment, then the contractor shall make a point repair excavation to uncover and remove or repair the obstruction. Such excavation shall be approved in writing by the Owner's representative prior to the commencement of the work and shall be considered as a separate pay item.

3.2 INSTALLATION

A. General:

1. The Contractor shall be responsible for confirming the locations of all branch service connections prior to installation and curing the CIPP.
2. The Contractor shall designate a location where the tube will be impregnated with resin using vacuum and distribution rollers to thoroughly saturate the tube prior to installation. The Contractor shall allow the Owner to inspect the materials and the "wet-out" procedure.
3. Resin Impregnation - The quantity of resin used for tube impregnation shall be sufficient to fill the volume of air voids in the tube with additional allowances for polymerization shrinkage and the loss of resin through cracks and irregularities in the original pipe wall. A roller system shall be used to uniformly distribute the resin throughout the tube.
4. After the installation is complete, the Contractor shall supply a suitable heat source and water recirculation equipment. The equipment shall be capable of uniformly raising the water temperature to a level required to effectively cure the resin.
5. The heat source shall be fitted with suitable monitors to gauge the temperature of the incoming and outgoing water supply. Another such gage shall be placed inside the tube at the downstream manhole at or near the bottom to determine the temperatures during cure. Water temperature in the pipe during the cure period shall be as recommended by the resin manufacturer.

6. Initial cure shall be deemed complete when inspection of the exposed portions of the tube appear to be hard and sound and the temperature sensor indicates that the temperature is of a magnitude to realize an exotherm. The cure period shall be of a duration recommended by the resin manufacturer and may require continuous recirculation of the water to maintain the temperature.
7. Cooldown: The Contractor shall cool the hardened pipe to a temperature below 100°F before relieving the hydrostatic head. Cool down may be accomplished by the introduction of cool water into the pipe to replace water being pumped out of the manhole.
8. Finish: The new pipe shall be cut off in the manhole at a suitable location. The finished product shall be continuous over the length of pipe reconstructed and be free from dry spots, delamination and lifts. It shall also meet the leakage requirements or pressure test specified below. During the warranty period, any defects, which will affect the integrity or strength of the product, shall be repaired at the Contractor's expense, in a manner mutually agreed upon by the Owner and the Contractor.
9. After the pipe has been cured in place, the Contractor shall reconnect the existing service connections. This shall be done from the interior of the pipeline without excavation using a robotic cutter. The Contractor shall certify he has a minimum of 2 complete working cutter units plus spare key components on the site before each installation. No additional payment will be made for excavations for the purpose of reopening connections and the Contractor will be responsible for all costs and liability associated with such excavation and restoration work.

B. Testing

1. The water tightness of the cured-in-place pipe shall be gauged while curing and under a positive head.
2. For each installed length designated by the Owner in the contract documents or purchase order, one CIPP sample shall be prepared from a section of the cured pipe at an intermediate manhole or at the termination point that has been installed through a like diameter pipe held in place by a suitable heat sink, such as sandbags. In areas with limited space and large diameter pipes, other sampling techniques may be required. The CIPP samples shall be tested in accordance with ASTM D-790 except that the full sample thickness shall be tested. The flexural properties of the samples shall meet the requirements specified in this section.
3. Visual inspection of the CIPP shall be in accordance with ASTM F1216, Section 8.4.

C. Cleanup

1. Upon acceptance of the installation work and testing, the Contractor shall reinstate the project area affected by his operations.

END 02735

ABV	ABOVE	CU YD	CUBIC YARD	HATCH	HATCHING	PM	PAVEMENT MARKING	STD	STANDARD
A/C	ACCESS CONTROL	CULV	CULVERT	HD	HEAD	PED	PEDESTAL	SBI	STATE BOND ISSUE
AC	ACRE	C&G	CURB & GUTTER	HDW	HEADWALL	PNT	POINT	SR	STATE ROUTE
ADJ	ADJUST	D	DEGREE OF CURVE	HDUTY	HEAVY DUTY	PC	POINT OF CURVATURE	STA	STATION
AS	AERIAL SURVEYS	DC	DEPRESSED CURVE	ha	HECTARE	PI	POINT OF INTERSECTION OF HORIZONTAL CURVE	SPBGR	STEEL PLATE BEAM GUARDRAIL
AGG	AGGREGATE	DET	DETECTOR	HMA	HOT MIX ASPHALT	PRC	POINT OF REVERSE CURVE	SS	STORM SEWER
AH	AHEAD	DIA	DIAMETER	HWY	HIGHWAY	PT	POINT OF TANGENCY	STY	STORY
APT	APARTMENT	DIST	DISTRICT	HORIZ	HORIZONTAL	POT	POINT ON TANGENT	ST	STREET
ASPH	ASPHALT	DOM	DOMESTIC	HSE	HOUSE	POLYETH	POLYETHYLENE	STR	STRUCTURE
AUX	AUXILIARY	DBL	DOUBLE	IL	ILLINOIS	PCC	PORTLAND CEMENT CONCRETE	S.E. RUN.	SUPERELEVATION RATE
AGS	AUXILIARY GAS VALVE (SERVICE)	DSEFL	DOWNSTREAM ELEVATION	IMP	IMPROVEMENT	PP	POWER POLE OR PRINCIPAL POINT	SURF	SURFACE
AVE	AVENUE	DI	DRAINAGE OR DRIVE	IN DIA	INCH DIAMETER	PRM	PRIME	SMK	SURVEY MARKER
AX	AXIS OF ROTATION	DR	DRAINAGE INLET OR DROP INLET	INL	INLET	PE	PRIVATE ENTRANCE	T	TANGENT DISTANCE
BK	BACK	DRV	DRIVEWAY	IDS	INTERSECTION DESIGN STUDY	PROF	PROFILE	T.R.	TANGENT RUNOUT DISTANCE
B-B	BACK TO BACK	DCT	DUCT	INV	INVERT	PGL	PROFILE GRADELINE	TEL	TELEPHONE
BKPL	BACKPLATE	EA	EACH	IP	IRON PIPE	PROJ	PROJECT	TB	TELEPHONE BOX
B	BARN	EB	EASTBOUND	IR	IRON ROD	PL	PROPERTY CORNER	TP	TELEPHONE POLE
BARR	BARRICADE	EOP	EDGE OF PAVEMENT	JT	JOINT	PR	PROPOSED	TEMP	TEMPORARY
BL	BASELINE	E-CL	EDGE TO CENTERLINE	Kg	KILOGRAM	R	RADIUS or RESIDENTIAL	TBM	TEMPORARY BENCH MARK
BGN	BEGIN	E-E	EDGE TO EDGE	km	KILOMETER	RR	RAILROAD	TD	TILE DRAIN
BM	BENCHMARK	ELEC	ELECTRICAL	LN	LANE	RRS	RAILROAD SPIKE	TBE	TO BE EXTENDED
BIND	BINDER	EL	ELEVATION	LT	LEFT	RPS	REFERENCE POINT STAKE	TBR	TO BE REMOVED
BIT	BITUMINOUS	ENTR	ENTRANCE	LIDAR	LIGHT DETECTION AND RANGING	REF	REFLECTIVE	TBS	TO BE SAVED
BTM	BOTTOM	EXC	EXCAVATION	LP	LIGHT POLE	RCCP	REINFORCED CONCRETE CULVERT PIPE	TWP	TOWNSHIP
BLVD	BOULEVARD	EX	EXISTING	LGT	LIGHTING	REINF	REINFORCEMENT	TR	TOWNSHIP ROAD
BRK	BRICK	EXPWAY	EXPRESSWAY	LF	LINEAL FEET OR LINEAR FEET	REM	REMOVAL	TS	TRAFFIC SIGNAL
BBOX	BUFFALO BOX	E	EXTERNAL DISTANCE OF HORIZONTAL CURVE	L	LITER OR CURVE LENGTH	RC	REMOVE CROWN	TSCB	TRAFFIC SIGNAL CONTROL BOX
BLDG	BUILDING	E	OFFSET DISTANCE TO VERTICAL CURVE	LC	LONG CHORD	REP	REPLACEMENT	TSC	TRAFFIC SYSTEMS CENTER
CATV	CABLE	F-F	FACE TO FACE	LNG	LONGITUDINAL	REST	RESTAURANT	TRVS	TRANSVERSE
CIP	CAST IRON PIPE	FA	FEDERAL AID	L SUM	LUMP SUM	RESURF	RESURFACING	TRVL	TRAVEL
CB	CATCH BASIN	FAP	FEDERAL AID INTERSTATE	MACH	MACHINE	RET	RETAINING	TRN	TURN
C-C	CENTER TO CENTER	FAS	FEDERAL AID PRIMARY	MB	MAIL BOX	RT	RIGHT	TY	TYPE
CL	CENTERLINE OR CLEARANCE	FAUS	FEDERAL AID SECONDARY	MH	MANHOLE	ROW	RIGHT-OF-WAY	T-A	TYPE A
CL-E	CENTERLINE TO EDGE	FP	FENCE POST	MATL	MATERIAL	RD	ROAD	TYP	TYPICAL
CL-F	CENTERLINE TO FACE	OPT	FIBER OPTIC	MED	MEDIAN	RDWY	ROADWAY	UNDGND	UNDERGROUND
CTS	CENTERS	FE	FIELD ENTRANCE	m	METER	RTE	ROUTE	USGS	U.S. GEOLOGICAL SURVEY
CERT	CERTIFIED	FH	FIRE HYDRANT	METH	METHOD	SAN	SANITARY	USEL	UPSTREAM ELEVATION
CHSLD	CHISELED	FL	FLOW LINE	M	MID-ORDINATE	SANS	SANITARY SEWER	USFL	UPSTREAM FLOWLINE
CS	CITY STREET	FB	FOOT BRIDGE	mm	MILLIMETER	SEC	SECTION	UTIL	UTILITY
CP	CLAY PIPE	FDN	FOUNDATION	mm DIA	MILLIMETER DIAMETER	SEED	SEEDING	VBOX	VALVE BOX
CLSD	CLOSED	FR	FRAME	MIX	MIXTURE	SHAP	SHAPING	VV	VALVE VAULT
CLID	CLOSED LID	F&G	FRAME & GRATE	MBH	MOBILE HOME	S	SHEET	VLT	VAULT
CT	COAT OR COURT	FRWAY	FREEWAY	MOD	MODIFIED	SH	SHOULDER	VEH	VEHICLE
COMB	COMBINATION	GAL	GALLON	MFT	MOTOR FUEL TAX	SHLD	SHOULDER	VP	VENT PIPE
C	COMMERCIAL BUILDING	GALV	GALVANIZED	N & BC	NAIL & BOTTLE CAP	SW	SIDEWALK OR SOUTHWEST	VERT	VERTICAL
CE	COMMERCIAL ENTRANCE	G	GARAGE	N & C	NAIL & CAP	SIG	SIGNAL	VPC	VERTICAL POINT OF CURVATURE
CONC	CONCRETE	GM	GAS METER	N & W	NAIL & WASHER	SOD	SODDING	VPI	VERTICAL POINT OF INTERSECTION
CONST	CONSTRUCT	GV	GAS VALVE	NC	NORMAL CROWN	SM	SOLID MEDIUM	VPT	VERTICAL POINT OF TANGENCY
CONTD	CONTINUED	GIS	GEOGRAPHICAL INFORMATION SYSTEM	NB	NORTHBOUND	SB	SOUTHBOUND	WM	WATER METER
CONT	CONTINUOUS	GRAN	GRANULAR	NE	NORTHEAST	SE	SOUTHEAST	WV	WATER VALVE
COR	CORNER	GR	GRATE	NW	NORTHWEST	SPL	SPECIAL	WMAIN	WATER MAIN
CORR	CORRUGATED	GRVL	GRAVEL	O/S	OFFSET	SD	SPECIAL DITCH	WB	WESTBOUND
CMP	CORRUGATED METAL PIPE	GND	GROUND	O&C	OIL AND CHIP	SQ FT	SQUARE FEET	WILDFL	WILDFLOWERS
CNTY	COUNTY	GUT	GUTTER	OLID	OPEN LID	m ²	SQUARE METER	W	WITH
CH	COUNTY HIGHWAY	GP	GUY POLE	PAT	PATTERN	mm ²	SQUARE MILLIMETER	WO	WITHOUT
CSE	COURSE	GW	GUY WIRE	PVD	PAVED	SQ YD	SQUARE YARD		
XSECT	CROSS SECTION	HH	HANDHOLE	PVMT	PAVEMENT	STB	STABILIZED		
m ³	CUBIC METER								
mm ³	CUBIC MILLIMETER								

Illinois Department of Transportation

PASSED BY *[Signature]* January 1, 2021
 ENGINEER OF POLICY AND PROCEDURES
 APPROVED BY *[Signature]* January 1, 2021
 ENGINEER OF DESIGN AND ENVIRONMENT

ISSUES 1-10-97

DATE	REVISIONS	STANDARD SYMBOLS, ABBREVIATIONS AND PATTERNS (Sheet 1 of 9)
1-1-21	Updated fonts, abbreviations and symbols.	
1-1-19	Added new symbols.	
		STANDARD 000001-08

ADJUSTMENT ITEMS

EX

PR

Structure To Be Adjusted		
Structure To Be Cleaned		
Main Structure To Be Filled		
Structure To Be Filled		
Structure To Be Filled Special		
Structure To Be Removed		
Structure To Be Reconstructed		
Structure To Be Reconstructed Special		
Frame and Grate To Be Adjusted		
Frame and Lid To Be Adjusted		
Domestic Service Box To Be Adjusted		
Valve Vault To Be Adjusted		
Special Adjustment		
Item To Be Abandoned		
Item To Be Moved		
Item To Be Relocated		
Pavement Removal and Replacement		

ALIGNMENT ITEMS

EX

PR

Baseline		
Centerline		
Centerline Break Circle		
Baseline Symbol		
Centerline Symbol		
PI Indicator		
Point Indicator		
Horizontal Curve Data (Half Size)	<p>EX. CURVE</p> <p>P.I. STA= Δ= D= R= T= L= E= e= T.R.= S.E. RUN= P.C. STA= P.T. STA=</p>	<p>CURVE</p> <p>P.I. STA= Δ= D= R= T= L= E= e= T.R.= S.E. RUN= P.C. STA= P.T. STA=</p>

BOUNDARIES ITEMS

EX

PR

Dashed Property Line		
Solid Property/Lot Line		
Section/Grant Line		
Quarter Section Line		
Quarter/Quarter Section Line		
County/Township Line		
State Line		
Chiseled Square Found		
Iron Pipe Found		
Iron Pipe Set		
Survey Marker		
Property Line Symbol		
Same Ownership Symbol (Half Size)		
Northwest Quarter Corner (Half Size)		
Section Corner (Half Size)		
Southeast Quarter Corner (Half Size)		

DRAINAGE ITEMS

EX

PR

Channel or Stream Line		
Culvert Line		
Grading & Shaping Ditches		
Drainage Boundary Line		
Paved Ditch		
Aggregate Ditch		
Pipe Underdrain		
Storm Sewer		
Flowline		
Ditch Check		
Headwall		
Inlet		
Manhole		
Summit		
Roadway Ditch Flow		
Swale		
Catch Basin		
Culvert End Section		
Water Surface Indicator		
Riprap		

HYDRAULICS ITEMS

EX

PR

Overflow		
Sheet Flow		
Hydrant Outlet		

STANDARD SYMBOLS, ABBREVIATIONS AND PATTERNS
(Sheet 2 of 9)

STANDARD 000001-08

Illinois Department of Transportation

PASSED: 4/11/2021 January 1, 2021
 ENGINEER OF POLICY AND PROCEDURES
 APPROVED: 4/11/2021 January 1, 2021
 ENGINEER OF DESIGN AND ENVIRONMENT

ISSUE: 1-197

EROSION & SEDIMENT CONTROL ITEMS

EX

PR

Cleaning & Grading Limits	
Dike	
Erosion Control Fence	
Perimeter Erosion Barrier	
Temporary Fence	
Ditch Check Temporary	
Ditch Check Permanent	
Inlet & Pipe Protection	
Sediment Basin	
Erosion Control Blanket	
Fabric Formed Concrete Revetment Mat	
Turf Reinforcement Mat	
Mulch Temporary	
Mulch Method 1	
Mulch Method 2 Stabilized	
Mulch Method 3 Hydraulic	

CONTOUR ITEMS

EX

PR

Approx. Index Line	
Approx. Intermediate Line	
Index Contour	
Intermediate Contour	

NON-HIGHWAY IMPROVEMENT ITEMS

EX

PR

Noise Attn./Levee	
Field Line	
Fence	
Base of Levee	
Mailbox	
Multiple Mailboxes	
Pay Telephone	
Advertising Sign	
ITS Camera	
Wind Turbine	
Cellular Tower	

Intelligent Transportation Systems

LANDSCAPING ITEMS

EX

PR

Contour Mounding Line	
Fence	
Fence Post	
Shrubs	
Mowline	
Perennial Plants	
Seeding Class 2	
Seeding Class 2A	
Seeding Class 4	
Seeding Class 4 & S Combined	

EXISTING LANDSCAPING ITEMS (contd.)

EX

PR

Seeding Class 5	
Seeding Class 7	
Seedlings Type 1	
Seedlings Type 2	
Sodding	
Mowstake w/Sign	
Tree Trunk Protection	
Evergreen Tree	
Shade Tree	

LIGHTING

EX

PR

Duct		
Conduit		
Electrical Aerial Cable		
Electrical Buried Cable		
Controller		
Underpass Luminaire		
Power Pole		

STANDARD SYMBOLS, ABBREVIATIONS AND PATTERNS
(Sheet 3 of 9)

STANDARD 000001-08

Illinois Department of Transportation

PASSED: *[Signature]* January 1, 2021
 ENGINEER OF POLICY AND PROCEDURES

APPROVED: *[Signature]* January 1, 2021
 ENGINEER OF DESIGN AND ENVIRONMENT

ISSUED: 1-18-97

**LIGHTING
(contd.)**

EX

PR

Pull Point



Handhole



Heavy Duty Handhole



Junction Box



Light Unit Comb.



Electrical Ground



Traffic Flow Arrow



High Mast Pole
(Half Size)



Light Unit-1



PAVEMENT (MISC.)

EX

PR

Keyed Long Joint



Keyed Long Joint w/Tie Bars



Sawed Long Joint w/Tie Bars



Bituminous Shoulder



Bituminous Taper



Stabilized Driveway



Widening



PAVEMENT MARKINGS

EX

PR

Handicap Symbol



RR Crossing



Raised Marker Amber 1 Way



Raised Marker Amber 2 Way



Raised Marker Crystal 1 Way



Two Way Turn Left



Shoulder Diag. Pattern



Skip-Dash White



Skip-Dash Yellow



Stop Line



Solid Line



Double Centerline



Dotted Lines



Illinois Department of Transportation

PASSED by *[Signature]* January 3, 2021
 ENGINEER OF POLICY AND PROCEDURES

APPROVED by *[Signature]* January 3, 2021
 ENGINEER OF DESIGN AND ENVIRONMENT

16-114 03/2018

**STANDARD SYMBOLS,
ABBREVIATIONS
AND PATTERNS**
(Sheet 4 of 9)

STANDARD 000001-08

PAVEMENT MARKINGS
(contd.)

EX

PR

CL 2Ln 2Way
RRPM 12.2 m (40') o.c.



CL 2Ln 2Way
RRPM 80' (24.4 m) o.c.



CL Multilane Div.
RRPM 40' (12.2 m) o.c.

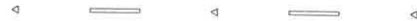

CL Multilane Div.
RRPM 80' (24.4 m) o.c.



CL Multilane Div. Dbl.
RRPM 80' (24.4 m) o.c.



CL Multilane Undiv.



Two Way Turn Left Line



Urban Combination Left



Urban Combination Right



Urban Left Turn Arrow



Urban Right Turn Arrow



Urban Left Turn Only

ONLY
ONLY
ONLY



Urban Right Turn Only



Urban Thru Only



Urban LT & RT Turn Arrow

Urban Thru Arrow

RAILROAD ITEMS

EX

PR

Abandoned Railroad



Railroad



Railroad Point



Control Box



Crossing Gate



Flashing Signal



Railroad Cant, Mast Arm



Crossbuck



REMOVAL ITEMS

EX

PR

Removal Tic



Bituminous Removal



Hatch Pattern



Tree Removal Single



RIGHT OF WAY ITEMS

EX

PR

Future ROW Corner Monument



ROW Marker



ROW Line



Easement



Temporary Easement

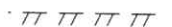

**STANDARD SYMBOLS,
ABBREVIATIONS
AND PATTERNS**
(Sheet 5 of 9)

STANDARD 000001-08

Illinois Department of Transportation

PASSED 11/19/21 January 1, 2021

ENGINEER OF POLICY AND PROCEDURES

APPROVED 11/19/21 January 1, 2021

ENGINEER OF DESIGN AND ENVIRONMENT

ISSUED 11-19-21

PAVEMENT MARKINGS
(contd.)

EX

PR

Urban U-Turn

Urban Combined U-Turn

Rural Combination Left

Rural Combination Right

Rural Left Turn Arrow

Rural Right Turn Arrow

Rural Left Turn Only

Rural Right Turn Only

Rural Thru Only

Rural Thru Arrow

Rural Lt & Rt Turn Arrow

Bike Lane Symbol

Bike Lane Text

Bike Path Shared

Bike Shared Roadway

Lane Drop Symbol

ONLY ONLY ONLY



BIKE LANE



Illinois Department of Transportation

PASSED *[Signature]* February 1, 2021
 ENGINEER OF PROJECT AND PROCEDURES

ISSUED 1-15-97

APPROVED *[Signature]* February 1, 2021
 ENGINEER OF DESIGN AND ENVIRONMENT

Wrong Way Arrow

**STANDARD SYMBOLS,
 ABBREVIATIONS
 AND PATTERNS**
(Sheet 6 of 9)

STANDARD 000001-08

**RIGHT OF WAY ITEMS
(contd.)**

	EX	PR
Access Control Line	—	— AC —
Access Control Line & ROW	— AC —	— AC —
Access Control Line & ROW with Fence	— AC —	— AC —
Excess ROW Line		— XS —

**ROADWAY PLAN
ITEMS**

	EX	PR
Cable Barrier	—○—○—○—○—	—●—●—●—●—
Concrete Barrier	—■—■—■—■—	—■—■—■—■—
Edge of Pavement	—	—
Bit Shoulders, Medians and C&G Line	—	—
Aggregate Shoulder	—	—
Sidewalks, Driveways	—	—
Guardrail	—□—□—□—□—	—■—■—■—■—
Guardrail Post	○	○
Traffic Sign	□	□
Corrugated Median	—■—■—■—■—	—■—■—■—■—
Impact Attenuator		—○—○—○—○—
North Arrow with District Office (Half Size)	↑	
Match Line		STA. 45+00
Slope Limit Line	—	—
Typical Cross-Section Line	—	—

ROADWAY PROFILES

	EX	PR
P.I. Indicator	△	△
Point Indicator	○	○
Earthworks Balance Point		⊗
Begin Point		◐
Vert. Curve Data	VPI = ELEV = L E =	VPI = ELEV = L E =
Ditch Profile Left Side	—	—
Ditch Profile Right Side	—	—
Roadway Profile Line	—	—
Storm Sewer Profile Left Side	—	—
Storm Sewer Profile Right Side	—	—

SIGNING ITEMS

	EX	PR
Cone, Drum or Barricade	○	○
Barricade Type II	—■—	—■—
Barricade Type III	—■—	—■—
Barricade With Edge Line	—■—	—■—
Flashing Light Sign	○	○
Panels I	—■—	—■—
Panels II	—■—	—■—
Direction of Traffic	→	→
Sign Flag (Half Size)	◇	◇

**SIGNING ITEMS
(contd.)**

	EX	PR
Reverse Left W1-4L (Half Size)		◇
Reverse Right W1-4R (Half Size)		◇
Two Way Traffic Sign W6-3 (Half Size)		◇
Detour Ahead W20-2(O) (Half Size)		◇
Left Lane Closed Ahead W20-5L(O) (Half Size)		◇
Right Lane Closed Ahead W20-5R(O) (Half Size)		◇
Road Closed Ahead W20-3(O) (Half Size)		◇
Road Construction Ahead W20-1-(O) (Half Size)		◇
Single Lane Ahead (Half Size)		◇
Transition Left W4-2L (Half Size)		◇
Transition Right W4-2R (Half Size)		◇

**STANDARD SYMBOLS,
ABBREVIATIONS
AND PATTERNS**
(Sheet 7 of 9)

STANDARD 000001-08

Illinois Department of Transportation

PASSED BY: [Signature] January 1, 2021

ENGINEER OF POLICY AND PROCEDURES

APPROVED BY: [Signature] January 1, 2021

ENGINEER OF DESIGN AND ENVIRONMENT

155355

15-1-1-01755

**SIGNING ITEMS
(contd.)**

EX

PR

One Way Arrow Lrg. W1-6-(O)
(Half Size)



Two Way Arrow Large W1-7-(O)
(Half Size)



Detour M4-10L-(O)
(Half Size)



Detour M4-10R-(O)
(Half Size)



One Way Left R6-1L
(Half Size)



One Way Right R6-1R
(Half Size)



Left Turn Lane R3-110L
(Half Size)



Keep Left R4-7AL
(Half Size)



Keep Left R4-7BL
(Half Size)



Keep Right R4-7AR
(Half Size)



Keep Right R4-7BR
(Half Size)



Stop Here On Red R10-6-AL
(Half Size)



Stop Here On Red R10-6-AR
(Half Size)



No Left Turn R3-2
(Half Size)



No Right Turn R3-1
(Half Size)



Road Closed R11-2
(Half Size)



Road Closed Thru Traffic R11-2
(Half Size)



Illinois Department of Transportation

PASSED: *[Signature]* January 1, 2021
 ENGINEER OF POLICY AND PROCEDURES

APPROVED: *[Signature]* January 1, 2021
 ENGINEER OF DESIGN AND ENVIRONMENT

ISSUED 11-6-19

STRUCTURES ITEMS

EX

PR

Box Culvert Barrel



Box Culvert Headwall



Bridge Pier



Bridge



Retaining Wall



Temporary Sheet Piling



**TRAFFIC SHEET
ITEMS**

EX

PR

Cable Number



Left Turn Green



Left Turn Yellow



Signal Backplate



Signal Section 8" (200 mm)



Signal Section 12" (300 mm)



Walk/Don't Walk Letters



Walk/Don't Walk Symbols



**TRAFFIC SIGNAL
ITEMS**

EX

PR

Galv. Steel Conduit



Underground Cable



Detector Loop Line



Detector Loop Large



Detector Loop Small



Detector Loop Quadrapole



**STANDARD SYMBOLS,
ABBREVIATIONS
AND PATTERNS**
(Sheet 8 of 9)

STANDARD 000001-08

**TRAFFIC SIGNAL
ITEMS (contd.)**

	EX	PR
Detector Raceway		
Aluminum Mast Arm		
Steel Mast Arm		
Veh. Detector Magnetic		
Conduit Splice		
Controller		
Gullbox Junction		
Wood Pole		
Temp. Signal Head		
Handhole		
Double Handhole		
Heavy Duty Handhole		
Junction Box		
Ped. Pushbutton Detector		
Ped. Signal Head		
Power Pole Service		
Priority Veh. Detector		
Signal Head		
Signal Head w/Backplate		
Signal Post		
Closed Circuit TV		
Video Detector-System		

**UNDERGROUND
UTILITY ITEMS**

	EX	PR	ABANDONED
Cable TV			
Electric Cable			
Fiber Optic			
Gas Pipe			
Oil Pipe			
Sanitary Sewer			
Telephone Cable			
Water Pipe			

UTILITIES ITEMS

	EX	PR
Controller		
Double Handhole		
Fire Hydrant		
GuyWire or Deadman Anchor		
Handhole		
Heavy Duty Handhole		
Junction Box		
Light Pole		
Manhole		
Monitoring Well (Gasoline)		
Pipeline Warning Sign		
Power Pole		
Power Pole with Light		
Sanitary Sewer Cleanout		
Splice Box Above Ground		
Telephone Splice Box Above Ground		
Telephone Pole		

**UTILITY ITEMS
(contd.)**

	EX	PR
Traffic Signal		
Traffic Signal Control Box		
Water Meter		
Water Meter Valve Box		
Profile Line		
Aerial Power Line		

VEGETATION ITEMS

	EX	PR
Deciduous Tree		
Bush or Shrub		
Evergreen Tree		
Stump		
Orchard/Nursery Line		
Vegetation Line		
Woods & Bush Line		

**WATER FEATURE
ITEMS**

	EX	PR
Stream or Drainage Ditch		
Waters Edge		
Water Surface Indicator		
Water Point		
Disappearing Ditch		
Marsh		
Marsh/Swamp Boundary		

**STANDARD SYMBOLS,
ABBREVIATIONS
AND PATTERNS**
(Sheet 9 of 9)

STANDARD 000001-08

Illinois Department of Transportation

PASSED BY: *M. J. B. J.* January 1, 2021
 ENGINEER OF POLICY AND PROCEDURES

APPROVED BY: *S. J. E. J.* January 1, 2021
 ENGINEER OF DESIGN AND ENVIRONMENT

ISSUED: 11-19-21

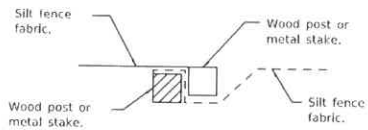

Place end-post (stake) of first silt fence adjacent to end-post (stake) of second silt fence with fabric positioned as shown.

STEP 1

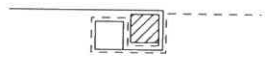

Rotate posts (stakes) together 180° clockwise and drive both posts (stakes) 18 (450) into ground.

STEP 2

ATTACHING TWO SILT FILTER FENCES
(Not applicable for J-hooks)

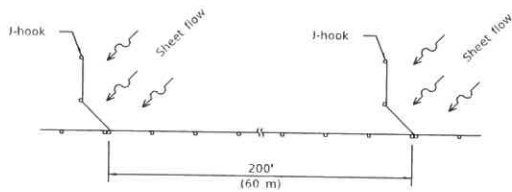

SILT FILTER J-HOOK PLACEMENT

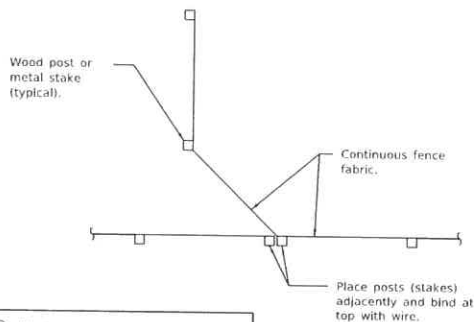

J-HOOK

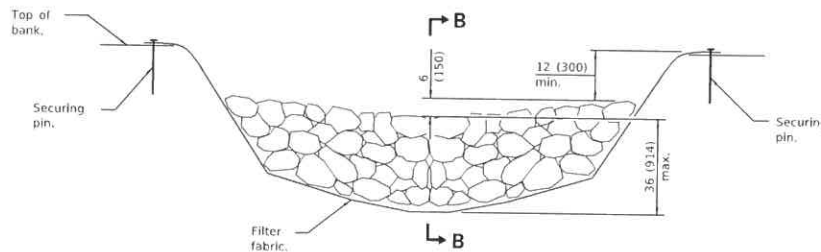

ELEVATION

* When the ditch check is within the clear zone and the road is open to traffic, the traffic approach slope of the aggregate shall be 1:4 (V:H).

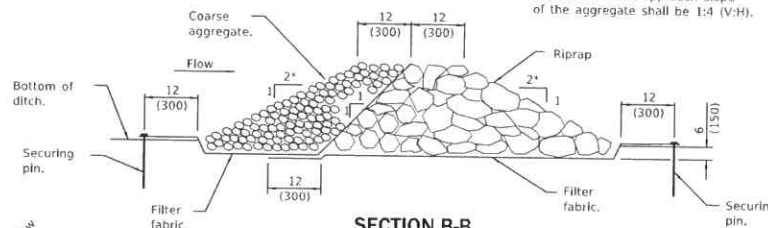

SECTION B-B

AGGREGATE DITCH CHECK

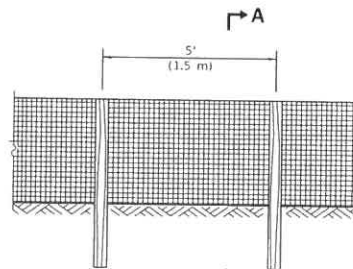

ELEVATION

SILT FILTER FENCE AS A PERIMETER EROSION BARRIER

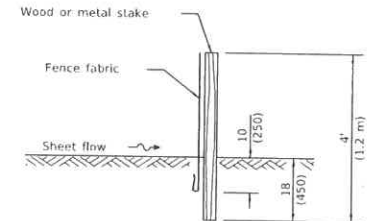

SLICE METHOD

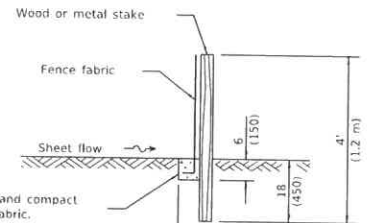

TRENCH METHOD

SECTION A-A

Excavate, backfill and compact trench to secure fabric.

GENERAL NOTES

The installation details and dimensions shown for perimeter erosion barriers shall also apply for inlet and pipe protection.

All dimensions are in inches (millimeters) unless otherwise shown.

TEMPORARY EROSION CONTROL SYSTEMS
(Sheet 1 of 2)

STANDARD 280001-07

Illinois Department of Transportation	
PASSED	January 1, 2013
ENGINEER OF POLICY AND PROCEDURES	<i>Michael Beard</i>
APPROVED	January 1, 2013
ENGINEER OF DESIGN AND ENVIRONMENT	<i>[Signature]</i>

DATE	REVISIONS
1-1-13	Corrected notation for flowline (f _l) on SEDIMENT BASIN ELEVATION.
1-1-12	Omitted hay/straw perimeter barrier. Added SLICE METHOD to SECTION A-A.

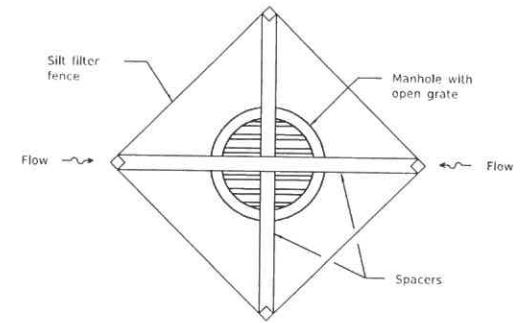
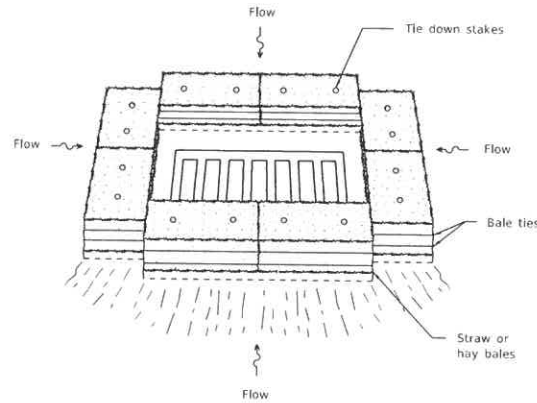
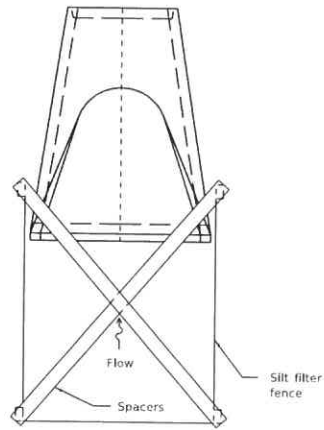
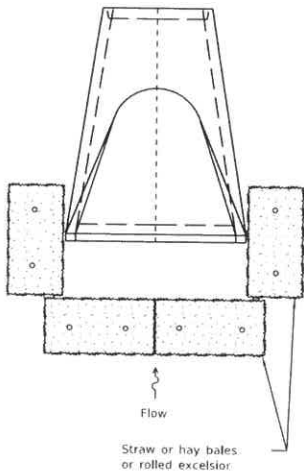

INLET AND PIPE PROTECTION

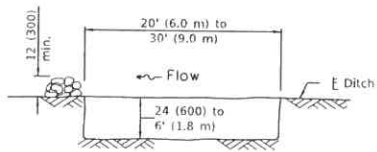

The performance of the basin will improve if put into a series.

ELEVATION

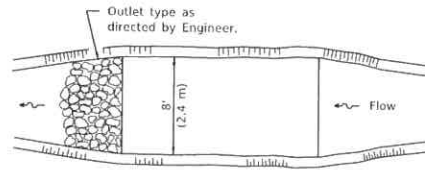

The long dimension should be parallel with the direction of the flow. Accumulated silt shall be removed anytime the basins become 75% filled.

PLAN

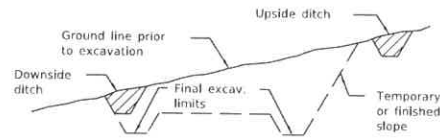

TYPICAL CUT CROSS-SECTION

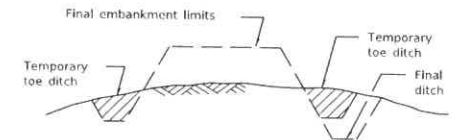

TYPICAL FILL CROSS-SECTION

TEMPORARY DITCHES FOR CUT & FILL SECTIONS

SEDIMENT BASIN

Illinois Department of Transportation	
PASSED	January 1, 2013
<i>Michael Brand</i>	
ENGINEER OF POLICY AND PROCEDURES	
APPROVED	January 1, 2013
<i>[Signature]</i>	
ENGINEER OF DESIGN AND ENVIRONMENT	
ISSUED	1-15-11

TEMPORARY EROSION CONTROL SYSTEMS

(Sheet 2 of 2)

STANDARD 280001-07

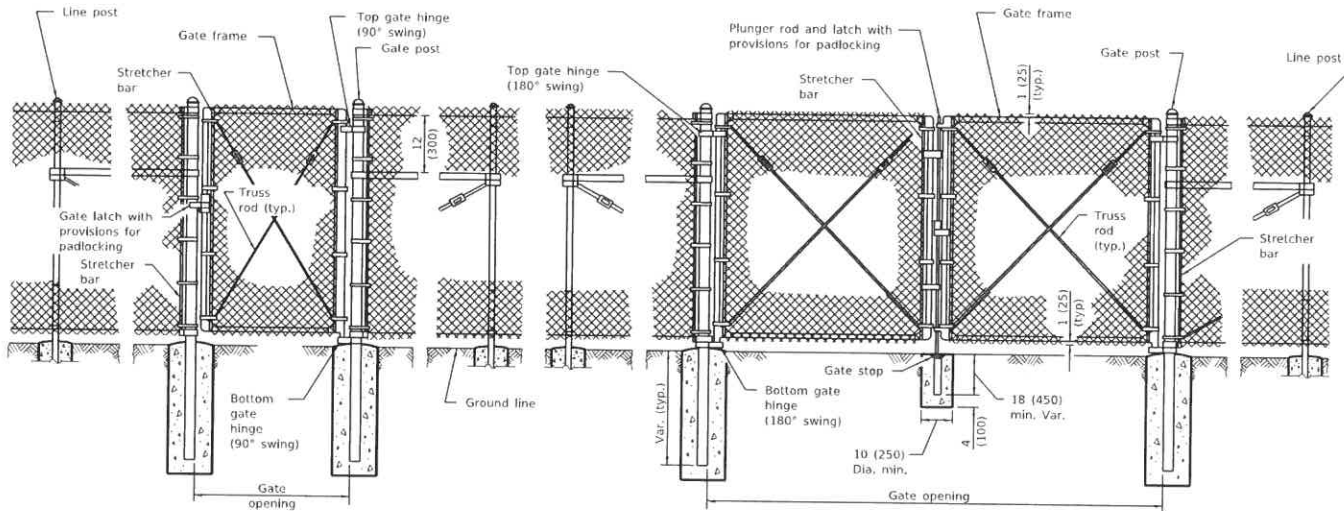

PEDESTRIAN GATE ARRANGEMENT

VEHICLE GATE ARRANGEMENT

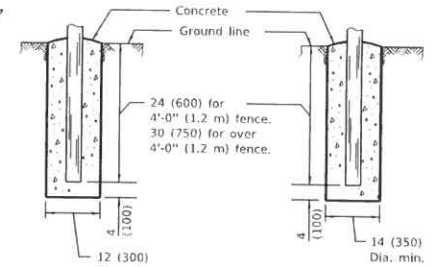

FOOTING FOR LINE POST

FOOTING FOR GATE & TERMINAL POST

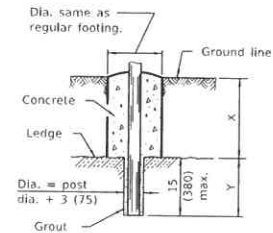

FOOTING FOR POST IN ROCK LEDGE

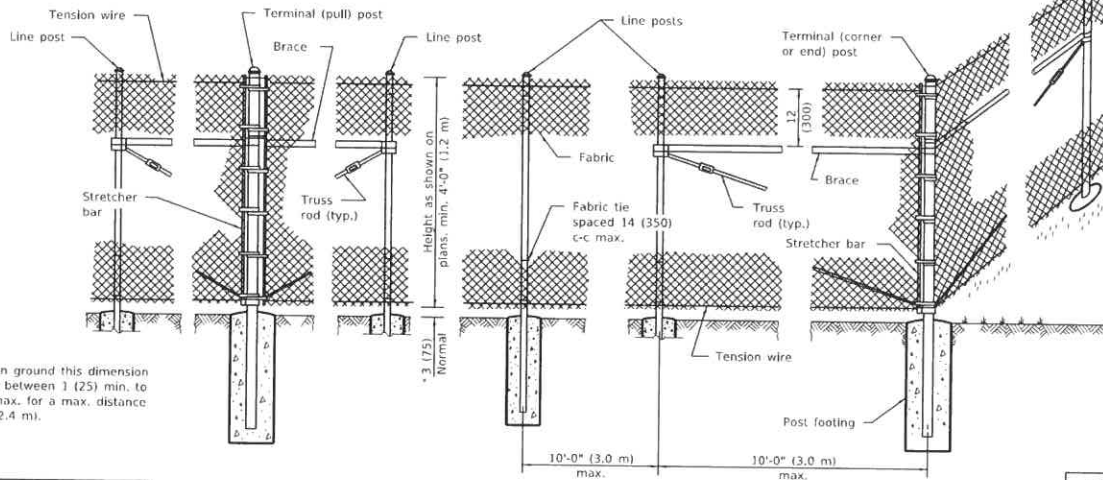

PULL POST ARRANGEMENT

LINE POST ARRANGEMENT

CORNER OR END POST ARRANGEMENT

* On uneven ground this dimension may vary between 1 (25) min. to 5 (125) max. for a max. distance of 8'-0" (2.4 m).

GENERAL NOTES
 Pull posts shall be placed at locations determined by the Engineer. They shall be placed at 660' (200 m) intervals between posts to which the ends of the fabric are clamped or midway between such posts when the distance is less than 1320' (400 m) and greater than 660' (200 m).

X + Y shall not exceed 24 (600), 30 (750), or 36 (900), as applicable. When X is 0 - 9 (0 - 225), 15 (380), or 21 (525), then Y = 15 (375) and the post shall be shortened as required. When X exceeds 9 (225), 15 (380), or 21 (525), then Y shall be decreased correspondingly.

All dimensions are in inches (millimeters) unless otherwise shown.

Illinois Department of Transportation

PASSED January 1, 2009

ENGINEER OF POLICY AND PROCEDURES

APPROVED January 1, 2009

ENGINEER OF DESIGN AND ENVIRONMENT

06/14 (07/06)

DATE	REVISIONS
1-1-09	Switched units to English (metric).
1-1-99	Rev. "pans" to "plans" in LINE POST ARRANGEMENT.

CHAIN LINK FENCE

(Sheet 1 of 3)

STANDARD 664001-02

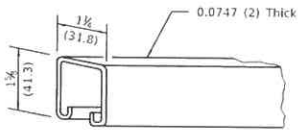

ROLL FORMED SECTION OF BRACE

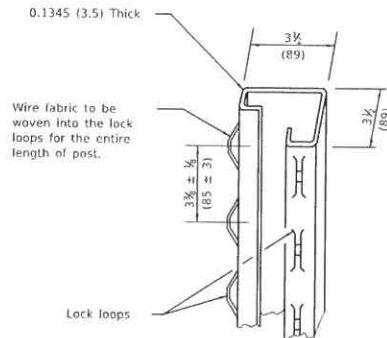

ROLL FORMED SECTION OF TERMINAL & GATE POST

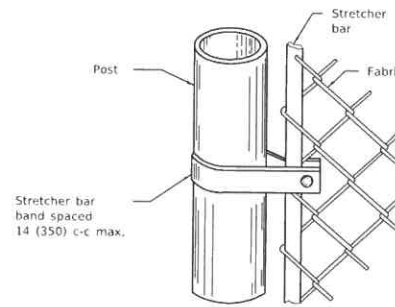

METHOD OF FASTENING STRETCHER BAR TO POST

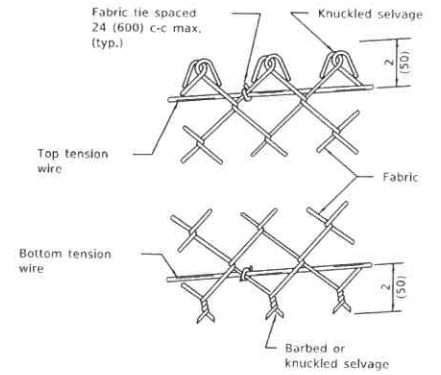

METHOD OF TYING FABRIC TO TENSION WIRES

LINE POST	
Section	lbs./ft. (kg/m)
Pipe Type A 1.90 (48.3) O.D.	2.72 (4.05)
Pipe Type B 1.90 (48.3) O.D.	2.28 (3.39)
Pipe Type C 1.90 (48.3) O.D.	2.26 (3.36)
H 1.875x1.625 (47.6x41.3)	2.72 (4.05)
C	1.60 (2.38)
I	2.30 (3.42)

TERMINAL POST	
Section	lbs./ft. (kg/m)
Pipe Type A 2.375 (60.3) O.D.	3.65 (5.43)
Pipe Type B 2.375 (60.3) O.D.	3.11 (4.63)
Pipe Type C 2.375 (60.3) O.D.	3.09 (4.60)
Roll Formed 3 1/2 x 3 1/2 (89.0 x 89.0)	See detail
Sq. Tubing 2 1/2 x 2 1/2 (63.5 x 63.5)	4.32 (6.43)

HORIZONTAL BRACES	
Section	lbs./ft. (kg/m)
Pipe Type A 1.66 (42.2) O.D.	2.27 (3.38)
Pipe Type B 1.66 (42.2) O.D.	1.83 (2.72)
Pipe Type C 1.66 (42.2) O.D.	1.82 (2.71)
H 1.31x1.5 (33.3x38.1)	2.25 (3.35)
Roll Formed 1 3/4 x 1 1/2 (41.3x31.8)	See detail

GATE FRAMES	
Section	lbs./ft. (kg/m)
Pipe Type A 1.66 (42.2) O.D.	2.27 (3.38)
Pipe Type B 1.66 (42.2) O.D.	1.83 (2.72)
Pipe Type C 1.66 (42.2) O.D.	1.82 (2.71)

GATE POSTS *							
Gate Opening * ft. (m)		Pipe Type A		Sq. Tubing		Pipe Type B	
Single	Double	Size (O.D.)	lbs./ft. (kg/m)	Size	lbs./ft. (kg/m)	Size (O.D.)	kg/m (lbs./ft.)
Up to 4 (1.2)	Up to 8 (2.5)	2.375 (60.3)	3.65 (5.43)	2 1/2 (63.5)	4.32 (6.43)	2.375 (60.3)	3.11 (4.63)
Over 4 (1.2) to 8 (2.5)	Over 8 (2.5) to 16 (5.0)	2.875 (73.0)	5.79 (8.62)	3 (76.2)	5.78 (8.60)	2.875 (73.0)	4.64 (6.91)
Over 8 (2.5) to 12 (3.6)	Over 16 (5.0) to 24 (7.4)	3.5 (89.0)	7.58 (11.28)	3 (76.2)	8.80 (13.10)	3.5 (89.0)	5.707 (8.49)

* The 3 1/2 x 3 1/2 (89.0 x 89.0) roll formed section as detailed may be used as gate posts for single gate up to 6' (1.8 m) and double gate up to 12' (3.6 m).

Illinois Department of Transportation

PASSED January 1, 2009

ENGINEER OF POLICY AND PROCEDURES

APPROVED January 1, 2009

ENGINEER OF DESIGN AND ENVIRONMENT

SDS/11-11-97

CHAIN LINK FENCE

(Sheet 2 of 3)

STANDARD 664001-02

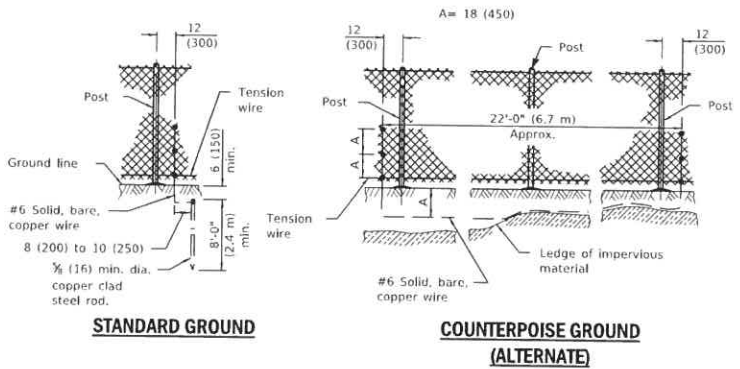

PROTECTIVE ELECTRICAL GROUNDS

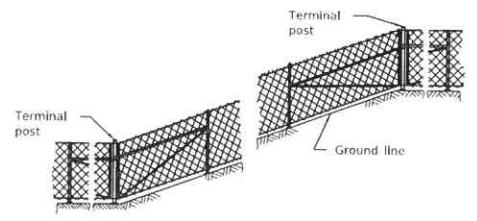

INSTALLATION ON SLOPES

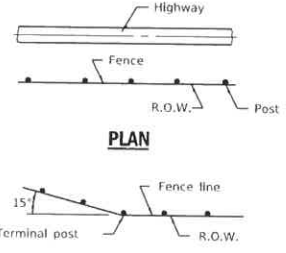

When fence line has a change in direction of 15° or more, a terminal post shall be placed as shown above.

Where angle is less than 15° and existing conditions require a terminal post, they shall be placed as directed by the Engineer.

INSTALLATION AT CORNERS

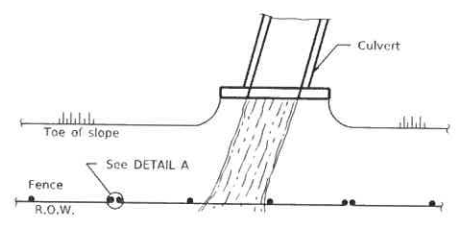

PLAN AT STREAM CROSSING

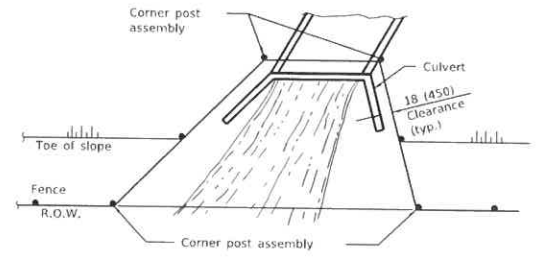

PLAN AT HEADWALL

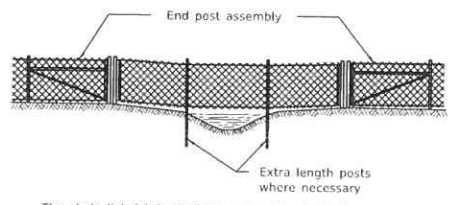

The chain link fabric shall be replaced by barbed wire strands at 12 (300) maximum centers between the double posts shown on DETAIL A when shown on the plans.

ELEVATION INSTALLATION OVER STREAM

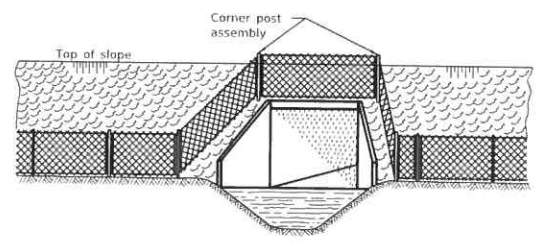

When the width of the culvert makes it necessary to anchor a post to the top of the culvert, a cast iron shoe or other device approved by the Engineer shall be used.

ELEVATION INSTALLATION AROUND HEADWALL

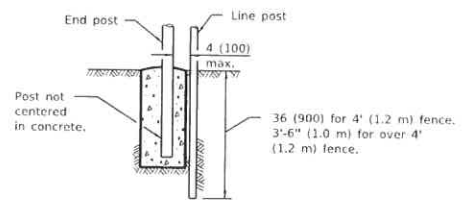

DETAIL A

Illinois Department of Transportation	
PASSED	January 1, 2009
ENGINEER OF POLICY AND PROCEDURES	<i>[Signature]</i>
APPROVED	January 1, 2009
ENGINEER OF DESIGN AND ENVIRONMENT	<i>[Signature]</i>

CHAIN LINK FENCE

(Sheet 3 of 3)

STANDARD 664001-02

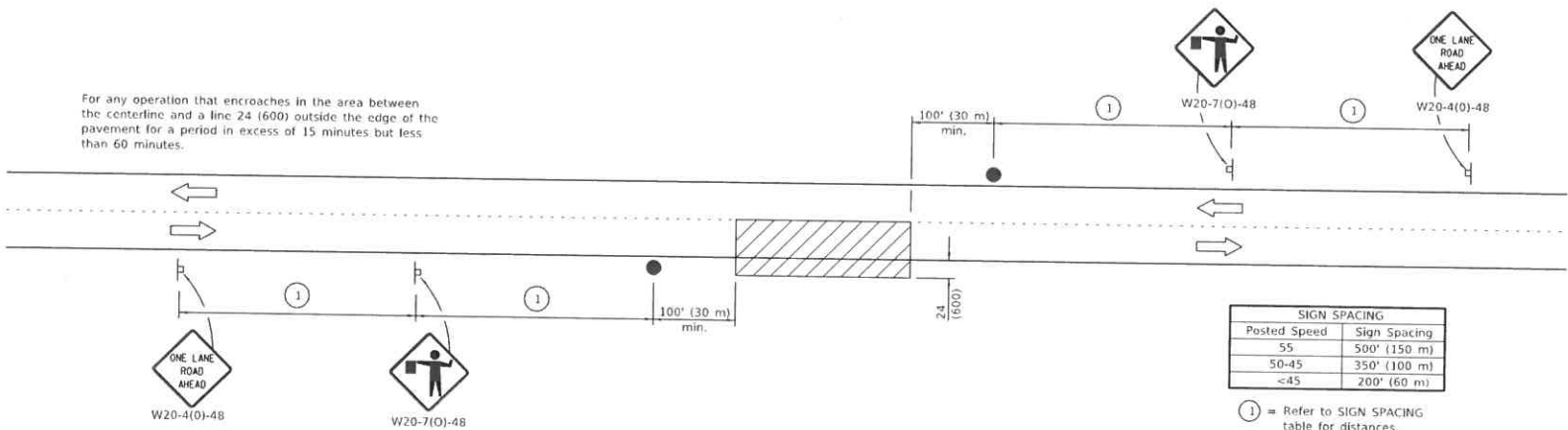
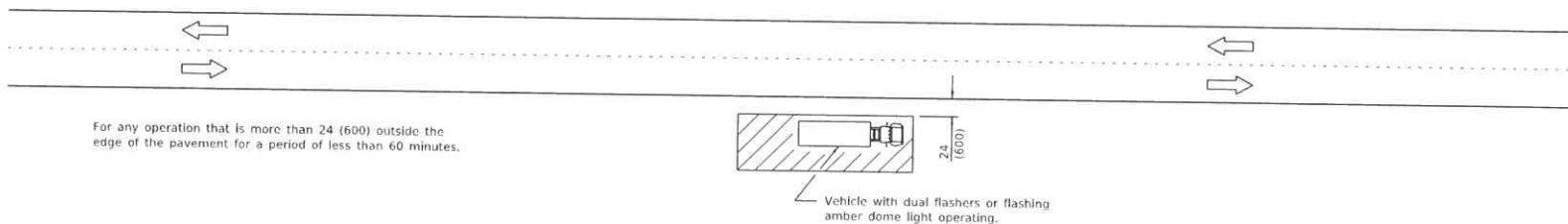
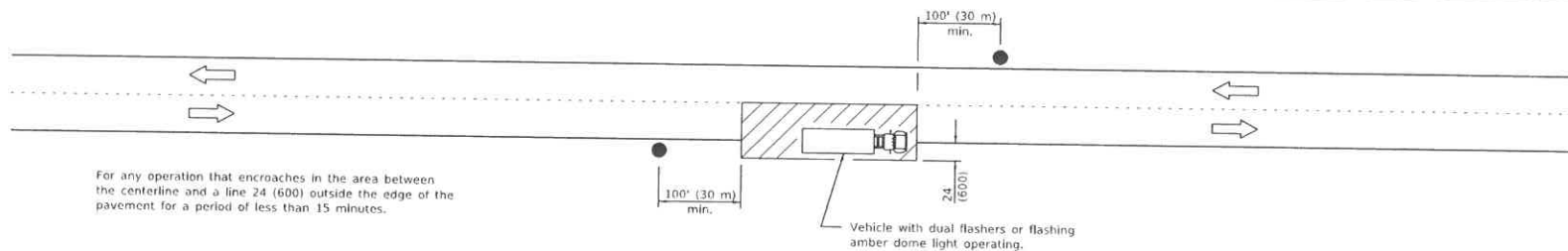

TYPICAL APPLICATIONS

- Marking patches
- Field survey
- String line
- Utility operations
- Cleaning up debris on pavement

SYMBOLS

- Work area
- Sign on portable or permanent support
- Flagger with traffic control sign

All dimensions are in inches (millimeters) unless otherwise shown.

Illinois Department of Transportation

PASSED: January 1, 2011

ENGINEER OF SAFETY ENGINEERING

APPROVED: January 1, 2011

ENGINEER OF DESIGN AND ENVIRONMENT

ES/SLD 1-107

DATE	REVISIONS
1-1-11	Revised flagger sign.
1-1-09	Switched units to English (metric).

LANE CLOSURE, 2L, 2W, SHORT TIME OPERATIONS

STANDARD 701301-04

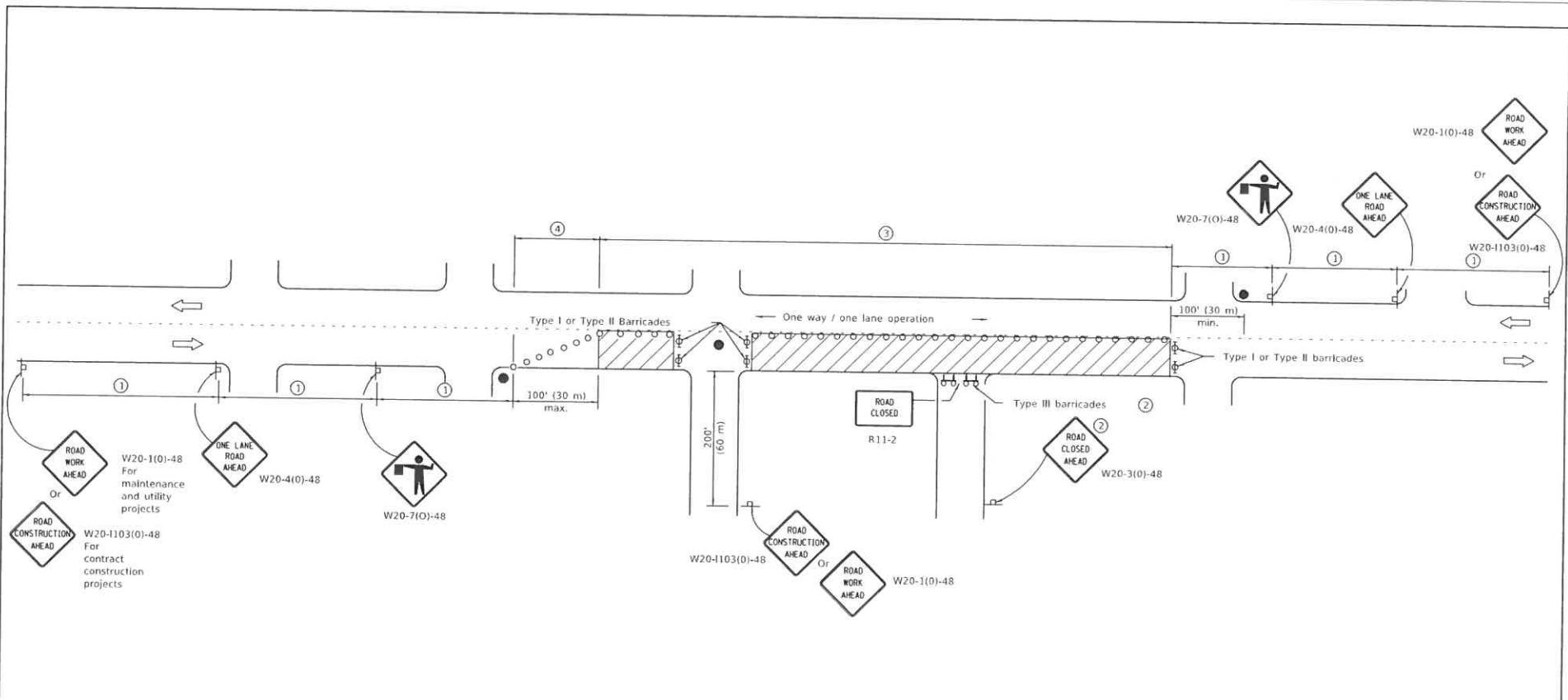

SIGN SPACING	
Posted Speed	Sign Spacing
55	500' (150 m)
50-45	350' (100 m)
<45	200' (60 m)

SYMBOLS

- Work area
- Cone, drum or barricade (not required for moving operations)
- Sign on portable or permanent support
- Flagger with traffic control sign
- Barricade or drum with flashing light
- Type III barricade with flashing lights

- ① Refer to SIGN SPACING TABLE for distances.
- ② For approved sideroad closures.
- ③ Cones at 25' (8 m) centers for 250' (75 m). Additional cones may be placed at 50' (15 m) centers. When drums or Type I or Type II barricades are used, the interval between devices may be doubled.
- ④ Cones, drums or barricades at 20' (6 m) centers.

GENERAL NOTES

This Standard is used where at any time, day or night, any vehicle, equipment, workers or their activities encroach on the pavement requiring the closure of one traffic lane in an urban area.

All dimensions are in inches (millimeters) unless otherwise shown.

Illinois Department of Transportation

PASSED January 1, 2011
 ENGINEER OF SAFETY ENGINEERING

APPROVED January 1, 2011
 ENGINEER OF DESIGN AND ENVIRONMENT

ISSUED 1-10-09

DATE	REVISIONS
1-1-11	Revised flagger sign.
1-1-09	Switched units to English (metric). Corrected sign No.'s.

**URBAN LANE CLOSURE,
2L, 2W, UNDIVIDED**

STANDARD 701501-06

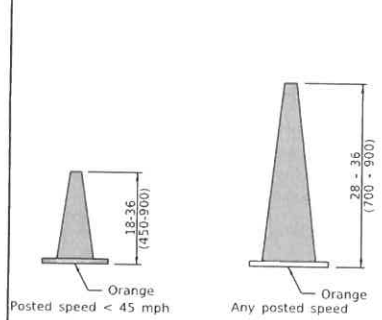

DAYTIME USE

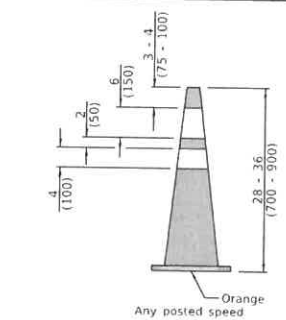

CONES

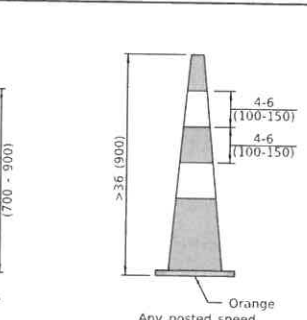

DAY OR NIGHTTIME USE

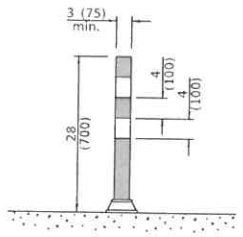

TUBULAR MARKER

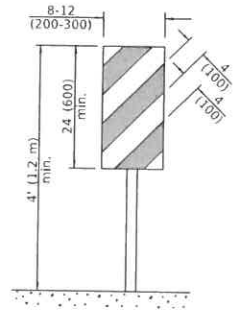

**VERTICAL PANEL
POST MOUNTED**

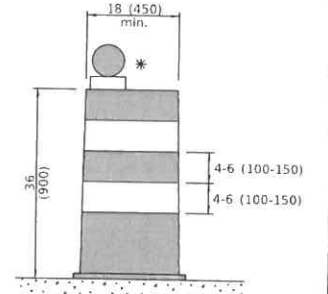

DRUM

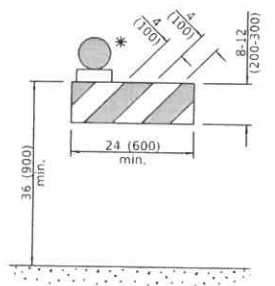

TYPE I BARRICADE

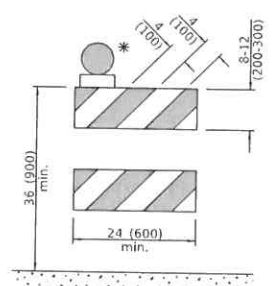

TYPE II BARRICADE

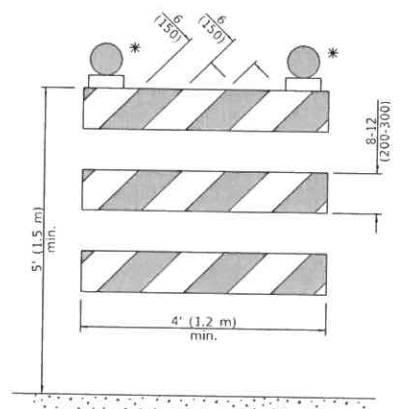

TYPE III BARRICADE

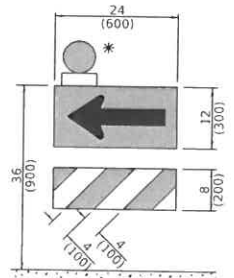

**DIRECTION INDICATOR
BARRICADE**

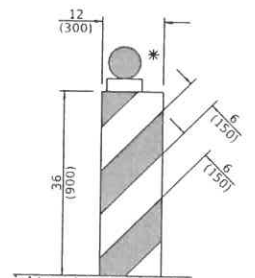

VERTICAL BARRICADE

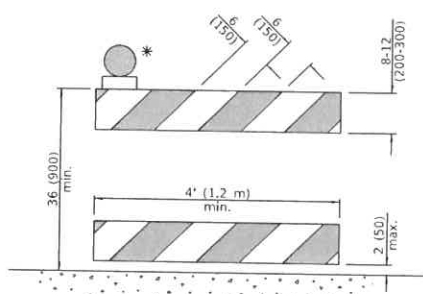

**DETECTABLE PEDESTRIAN
CHANNELIZING BARRICADE**

* Warning lights (if required)

GENERAL NOTES

All heights shown shall be measured above the pavement surface.

All dimensions are in inches (millimeters) unless otherwise shown.

Illinois Department of Transportation

APPROVED January 1, 2019

 ENGINEER OF SAFETY PROGRAMS AND ENGINEERING

APPROVED January 1, 2019

 ENGINEER OF DESIGN AND ENVIRONMENT

CITY ADDRESS

DATE	REVISIONS
1-1-19	Revised cone usage and added cones >36" (900 mm) height.
1-1-18	Revised END WORK ZONE SPEED LIMIT sign from orange to white background.

TRAFFIC CONTROL DEVICES

(Sheet 1 of 3)

STANDARD 701901-08

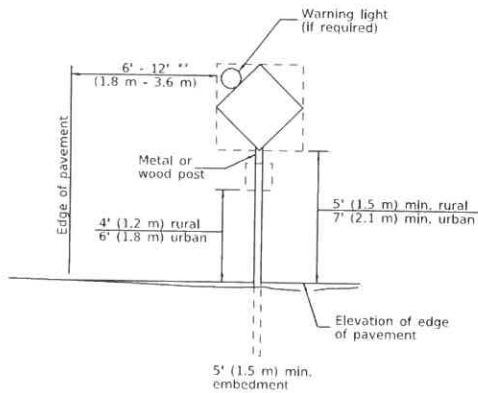

POST MOUNTED SIGNS

** When curb or paved shoulder are present this dimension shall be 24 (600) to the face of curb or 6' (1.8 m) to the outside edge of the paved shoulder.

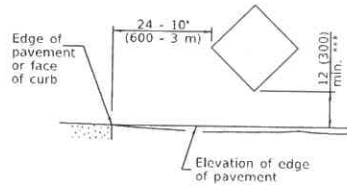

SIGNS ON TEMPORARY SUPPORTS

*** When work operations exceed four days, this dimension shall be 5' (1.5 m) min. If located behind other devices, the height shall be sufficient to be seen completely above the devices.

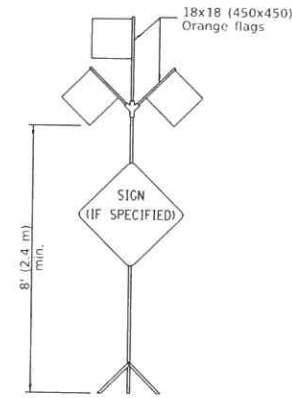

HIGH LEVEL WARNING DEVICE



W12-1103-4848

WIDTH RESTRICTION SIGN

XX'-XX" width and X miles are variable.

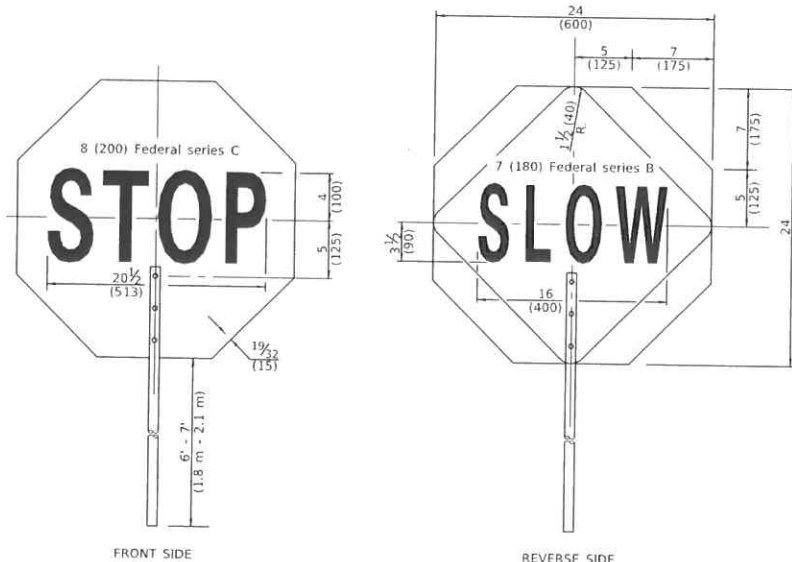

FRONT SIDE

REVERSE SIDE

FLAGGER TRAFFIC CONTROL SIGN



G20-1104(0)-6036



G20-1105(0)-6024

This signing is required for all projects 2 miles (3200 m) or more in length.

ROAD CONSTRUCTION NEXT X MILES sign shall be placed 500' (150 m) in advance of project limits.

END CONSTRUCTION sign shall be erected at the end of the job unless another job is within 2 miles (3200 m).

Dual sign displays shall be utilized on multi-lane highways.

WORK LIMIT SIGNING

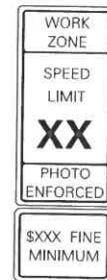

W21-III5(0)-3618

R2-1-3648

R10-1108p-3618 ****

R2-1106p-3618

Sign assembly as shown on Standards or as allowed by District Operations.

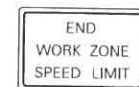

G20-1103-6036

This sign shall be used when the above sign assembly is used.

HIGHWAY CONSTRUCTION SPEED ZONE SIGNS

**** R10-1108p shall only be used along roadways under the jurisdiction of the State.

Illinois Department of Transportation

APPROVED January 1, 2019
[Signature]
 ENGINEER OF SAFETY PROG. AND ENGINEERING

APPROVED January 1, 2019
[Signature]
 ENGINEER OF DESIGN AND ENVIRONMENT

01/14 03/20/20

TRAFFIC CONTROL DEVICES

(Sheet 2 of 3)

STANDARD 701901-08

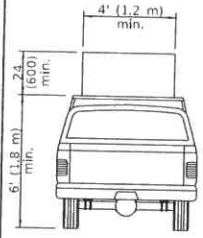

**TYPE A
ROOF
MOUNTED**

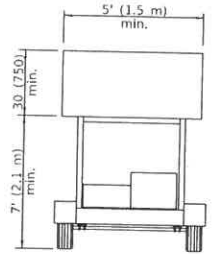

**TYPE B
ROOF OR TRAILER
MOUNTED**

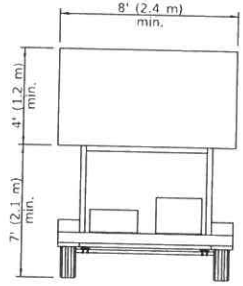

**TYPE C
TRAILER
MOUNTED**

ARROW BOARDS

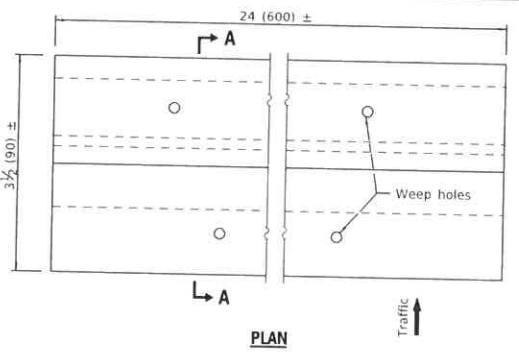

PLAN

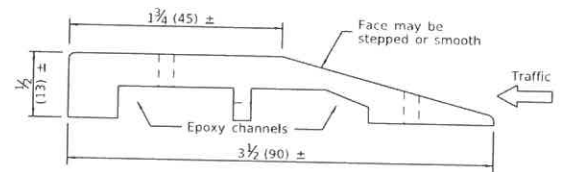

SECTION A-A

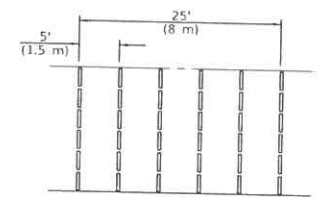
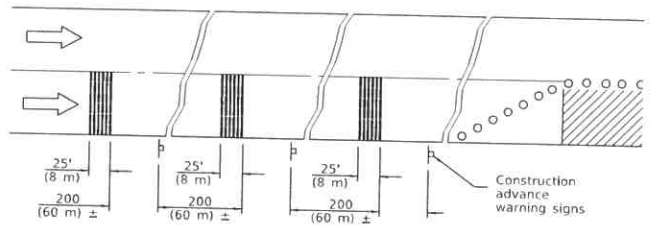

TYPICAL INSTALLATION

TEMPORARY RUMBLE STRIPS

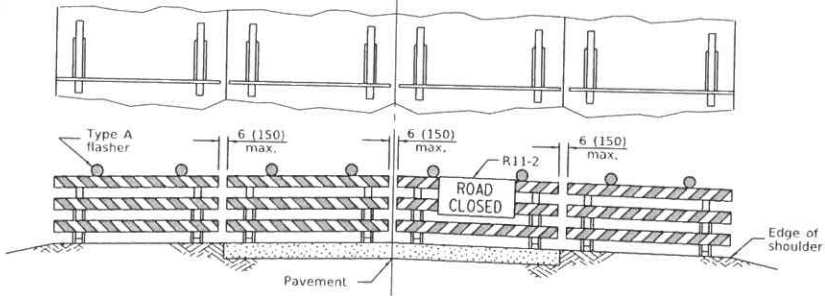

ROAD CLOSED TO ALL TRAFFIC

ReflectORIZED striping may be omitted on the back side of the barricades. If a Type III barricade with an attached sign panel which meets NCHRP 350 is not available, the sign may be mounted on an NCHRP 350 temporary sign support directly in front of the barricade.

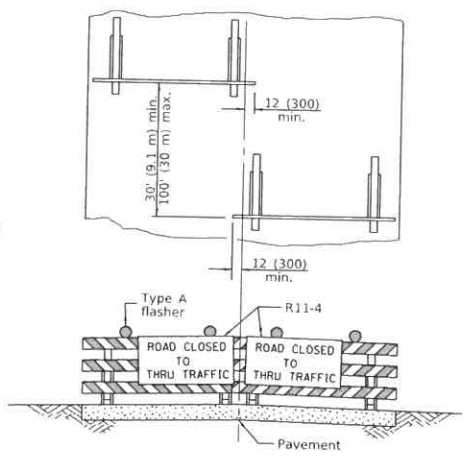

ROAD CLOSED TO THRU TRAFFIC

ReflectORIZED striping shall appear on both sides of the barricades. If a Type III barricade with an attached sign panel which meets NCHRP 350 is not available, the signs may be mounted on NCHRP 350 temporary sign supports directly in front of the barricade.

**TYPICAL APPLICATIONS OF
TYPE III BARRICADES CLOSING A ROAD**

Illinois Department of Transportation

APPROVED: January 2, 2019
Cynthia A. ...
 ENGINEER OF SAFETY PROG. AND ENGINEERING

APPROVED: January 1, 2019
...
 ENGINEER OF DESIGN AND ENVIRONMENT

EP-14 (07/05)

**TRAFFIC CONTROL
DEVICES**

(Sheet 3 of 3)

STANDARD 701901-08